



# Niko Home Control

Your home works better with Niko

PROFESSIONAL | TRADITIONAL WIRING

**niko**  
Illuminating ideas.



# Contents

Introduction: Your home works better with Niko Home Control .....	2
Make every home smart with Niko Home Control .....	8
The reasons why installers choose Niko Home Control .....	10
Comfortable, safe, energy conscious and independent living.....	12
Simple installation for traditional wiring .....	16
Wireless smart hub for Niko Home Control .....	17
Connected single and double switch .....	18
Connected dimmer .....	19
Connected motor control .....	20
Connected wireless motion detector .....	21
Connected socket outlet .....	23
Wireless controls .....	23
Touchswitch .....	24
Touchscreen .....	26
External video unit .....	27
<b>The possibilities of Niko Home Control for traditional wiring .....</b>	<b>28</b>
Lighting .....	30
Control your roll-down shutters, sun blinds and curtains .....	32
Control the front door .....	34
Living safely .....	36
Audio control .....	38
Heating .....	40
Energy management .....	42
Ventilation .....	44
<b>The Niko Academy: become the best installer with Niko Home Control .....</b>	<b>48</b>
<b>Niko Home Control online .....</b>	<b>50</b>
<b>Flush surround plates .....</b>	<b>52</b>
<b>Product overview Niko Home Control for traditional wiring .....</b>	<b>57</b>



# Introduction

## Your home works better with Niko Home Control

**Live more comfortably and safer, whilst saving maximum energy.** Niko Home Control is the electrical installation that allows you to control the lighting, heating, ventilation, roll-down shutters, air conditioning and curtains from a central location in your home (or anywhere in the world) and stay in control of your front door. The possibilities of Niko Home Control? They are endless. Thanks to its timeless design, the system fits seamlessly into your interior.

New buildings, conversions, major and minor renovations: **thanks to Niko Home Control you can fulfil every home automation requirement, suiting every project, budget and customer.** For your customers with new buildings, conversions or major renovations, Niko Home Control for **bus wiring** is the ideal solution. The flexibility of the system provides them with endless possibilities for expansion in the future. For customers who want to make their home smart without any demolition or want to do partial renovations on a limited budget, Niko Home Control can be installed on **traditional wiring**.

### Smart open system

Do your customers have smart systems from other brands in their home? Niko Home Control is easy to connect to the systems from various **high-quality partners**. Automatic connection to the installation. In 1,2,3 your customer can adjust the sun blinds, open a rooftop window from the ground floor, control the air quality any time of day or control their Sonos or Bose music installation.

### Belgian quality and expertise

With **100 years of experience**, including over 20 years in home automation, Niko is the market leader and an established name in Belgium. With Niko Home Control, you're choosing genuine Belgian expertise. Niko also has a great reputation across Europe. Innovation and quality are at the heart of everything we do.

### Try Niko Home Control yourself

Your customers will almost certainly want to see how Niko Home Control works. Invite your customers to the Niko Inspiration Center and let them get acquainted with **the smart home of the future**. Discover the different components of Niko Home Control and try them out yourself. Our professional team will answer all your questions, help you and give you all the information you want.

**Niko Inspiration Center:** Steenhouwersvest 54, 2000 Antwerp.

Open Tuesday to Saturday, from 10am to 6pm (you're advised to make an appointment).

Every 1st Sunday of the month from 1pm to 6pm (by appointment).

# GROUNDBREAKING



Complete control for  
every home, every time.



NOT  
WALL BREAKING



# Niko Home Control

## Groundbreaking, not wall breaking

**Complete control over your home, at all times.** Whether it's a new build, total renovation or partial renovation, with Niko Home Control you now have the possibility to make your home smarter for every project and every budget. Even **without channelling or drilling**, because you don't need to adapt your existing wiring. You can start with an affordable basic installation **which you can gradually extend in the future.**

That way, Niko Home Control offers a wide range of new possibilities for every home. Lighting, heating, ventilation, roll-down shutters, sun blinds, sound systems, smart energy meters, etc. You control everything in the house centrally via Niko Home Control. This not only provides additional **comfort**, but also makes your home **more secure**, flexible and energy-efficient.

### **Niko Home Control, one ecosystem:**

- available for every type of cabling, project and budget
- smart open system
- award-winning design
- Belgian quality and expertise, for more than 100 years already





# Make every home smart with Niko Home Control

With Niko Home Control you have a solution to help all your customers make their home smart. Whether you install Niko Home Control on bus wiring or traditional wiring, you always use the same platform and the same user-friendly programming software. Your customer also controls their installation with the existing user software and intuitive app.

## Bus Wiring: Complete home automation, endless possibilities and flexible control

Is your customer building a new house or extensively renovating a current home and also replacing the electrical wiring? Then choose the flexibility and future stability of Niko Home Control for bus wiring.

All of the system's components communicate with each other via the connected controller. This makes the system smart, gives it an unlimited number of possibilities and the customers have the flexibility to expand their installation in the future. Do your customers want an extra switch or sensor? They can be easily added without having to adapt the wiring. Do you want to connect smart systems from our partner brands to Niko Home Control? That's also possible with Niko Home Control for bus wiring.

## Traditional wiring: Make your customer's home smart without cutting or breaking

In **existing homes with traditional wiring** you can reuse the existing electrical wiring and fuse boxes with Niko Home Control. No extra space is needed in the electrical cabinet. The original switches and socket outlets in the existing installation can be easily replaced by connecting switches and socket outlets that you configure according to your customer's wishes.

Standard functions don't need to be programmed, they work automatically. Do you want to add more functionalities and give your customer more comfort? All you have to do is add **the wireless smart hub**. You can start programming immediately and give your customers almost the same possibilities as an installation with bus wiring. And because your customer's existing system is reused, you can offer them Niko Home Control without the added costs for new wiring.

If you install Niko Home Control on traditional wiring, the possibilities for expansion are more limited. You can't mount the switches and socket outlets on the wall, they must be flush-mounted.

**Niko Home Control for bus wiring**  
Complete flexibility, endless possibilities

**Niko Home Control for Traditional wiring**  
Low barrier, standard functions work without programming

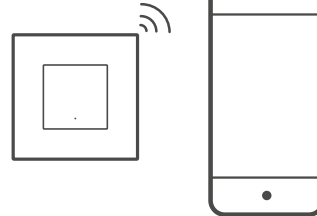
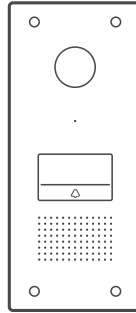
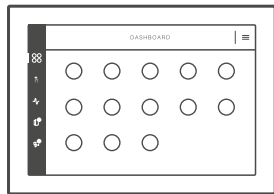

**The connected controller**  
One main brain



**Flexibility of operation**  
User-friendly design,  
fewer controls needed



**Heating – ventilation**  
Controlling heating  
and ventilation



**Digital / Analogue IN**  
Smoke detection, CO2 detection,  
water leaks, external alarm



**The wireless smart hub**  
for Niko Home Control  
Connect the controls  
and sensors to the Internet

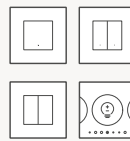

**Connected controls**  
Basic controls: switches, socket outlets,  
dimmers, roll-down shutter control,  
motion detectors



compatibel met onze partners



compatibel met onze partners



# Why installers choose Niko Home Control

## Traditional wiring

Niko Home Control has already been proven to be an affordable and inspiring solution in many homes. Installers are convinced by, among others, the **user-friendliness and ease of installation** in which they can quickly program a home with Niko Home Control. And the programming software makes it easy for your customers to make simple modifications to the installation themselves.

The needs of your customers are central for Niko Home Control. Our products meet their needs as closely as possible without losing sight of user friendliness.

You can install Niko Home Control for traditional wiring in **every home with a traditional installation**. **Connected switches** can be easily installed instead of conventional switches. Without any additional configuration, they do exactly the same thing. Add a **wireless smart hub** to the installation? You can program the components with the same user-friendly software you already used today to program Niko Home Control.

### An easy sell

Niko Home Control for traditional wiring consists of several different components. Each component has a specific function. There are connected versions for all conventional switches, dimmers, socket outlets, .... Because the **logic is in the component itself, you won't need any additional cabinet modules**. This allows you to create a customised quote for your customer: you only need to take the cost of the components and your installation time into account. Modifications to the home's electrical circuit board? Not necessary.

Because you work per function, you can easily add, for example, an extra light point to the installation. Without having to make complex calculations.

### Easy to install

Niko Home Control for traditional wiring is easy to install. You do what you've been doing for years: connect the components just like standard switches. Do you need controls in other locations for the same device? Thanks to the **extension possibility**, you can easily install an extra push button that links it to the connected component.

Did you forget a cable? Or do your customers want an extra switch somewhere where there is no cabling? No problem. Thanks to the **wireless buttons**, you can add a switch anywhere you want. Even at the base of a glass partition.

### Easy to configure

Do your customers want to turn their connected components into a complete Niko Home Control installation? Then just add a **wireless smart hub** to the installation. This allows you to configure **the installation with the programming software**. Whether its moods or an all-off function: you configure them with a couple of mouse clicks.

### Easy to expand

And **systems from our partner brands** that are linked together via the home network or the Internet (Sonos, Bose, Renson, NIBE and Smappee), are compatible with Niko Home Control for traditional wiring. Your customers' Sonos or Bose speakers can be connected effortlessly to their installation.

### Easy to control

And we've made it easy for your customers as well. They only need **1 smartphone app** to control their connected installation. There is no difference in use or in functionality, whether they have Niko Home Control for bus wiring or for traditional wiring.

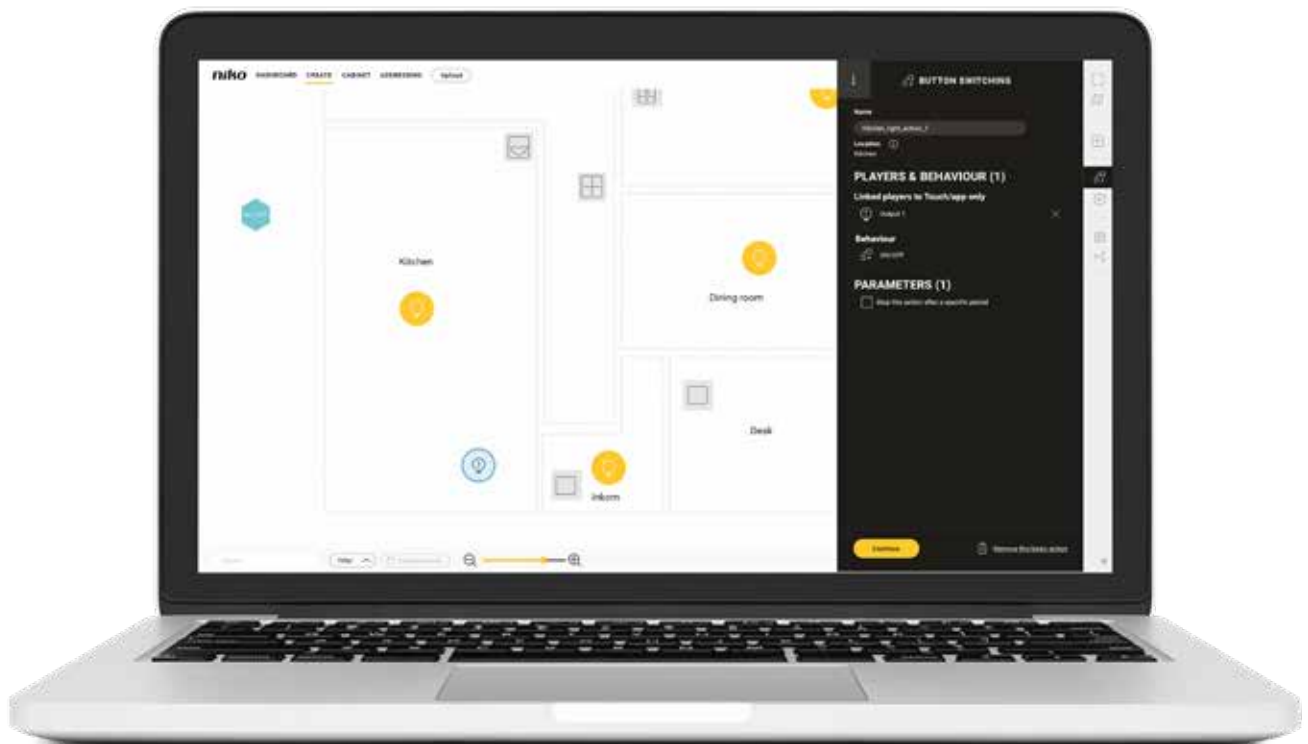

# Future-proof living in a connected world

## Convince your customers too

Every family is different. And everyone evolves. Niko Home Control is easily adapted to **the needs of all your customers and their family**, no matter how they might evolve. Now and in the future.

Your customers want to live more comfortably, safer and energy conscious? Or adapt their home to remain living there longer? **It's possible with Niko Home Control, whatever their type of home or budget.** In a **user-friendly way**, they control lighting, roll-down shutters, sun blinds, music installations... While heating and ventilating more consciously, and saving energy.

Thanks to Niko Home Control they have **complete control over their home** via a touchscreen, their tablet or smartphone, anywhere in the world. You only link those functions and locations to each touchscreen that they wish to control from that particular touchscreen. With the user-friendly programming software, your customer can personalise their installation and make changes without any risks.





## Essentials

The basic installation already offers your customers more possibilities than a traditional electrical installation would. With Niko Home Control, the resident chooses simple, intuitive and always modifiable controls via push buttons with clear function symbols. They can set preferences and add or modify moods, names and automatic time settings.

With one push of the everything-off button, lighting and other systems you want shut down are all turned off. Programmed timers switch lights on and off, giving you even more control. Presence simulation and a panic button promote a feeling of safety. With their smartphone and tablet, they are always in control of their home, anywhere in the world.



## Comfortable living

Niko Home Control can not only be controlled via buttons, your smartphone or tablet, but also with a central touchscreen on the wall. With dimmers, motion detectors and mood control, your customers choose complete ease of use. For each activity they can set the right mood, which can be chosen with one push of the button. Automatically controlled lighting outside, in the toilet, storage areas and the dressing room, provides more comfort and saves energy.



## Living safely

If Niko Home Control detects something suspicious, your customers will receive a notice on their smartphone. The lighting is automatically switched on as soon as it gets dark or once motion is detected. A push on the panic button switches all lights on at once. If they're not home, the presence simulation automatically controls the lighting and roll-down shutters in the morning and evening. And thanks to the video unit at the front door, they can use their touchscreen, tablet or smartphone to see who is at the door.



## Energy-conscious living

Smart ventilation responds to presence and the lights in the room. roll-down shutters, curtains and sun blinds are controlled automatically. With connected switchable socket outlets, your customers can easily turn connected devices on or off and measure the energy consumption of those devices. Via the touchscreen, smartphone and/or tablet, they have access to their home's energy consumption at all times. Niko Home Control controls our partners' ventilation, heating and energy management systems automatically.



## Independent living





Easily adapt Niko Home Control to the new needs of your existing customers. Stick or screw our wireless controls precisely where your customers need them. Electrical devices that can lead to dangerous situations, such as ovens or hobs can be turned off automatically.

In emergency situations, a wireless panic button quickly warns a family member or trusted person. And when Niko Home Control does not register any movement for several hours when your customers are home, a family member will receive an alert on their smartphone. No matter what you program: your customers remain in control and can easily turn off any function.





# What can Niko Home Control do for your customers?

Functionality	Niko Home Control installation		
	Traditional wiring	Bus wiring	
	Switch lights on or off	●	●
	Connections wherever you like (socket outlet, Internet, TV)	●	●
	Central control with smartphone/tablet	●	●
	Make things atmospheric with one press of a button	●	●
	All-off button	●	●
	Presence simulation	●	●
	Panic function	●	●
	Built-in alarm and alert service	●	●
	Central control via touchscreen and touchswitch	●	●
	Make things atmospheric with dimmed light circuits	●	●
	Smooth operation via display controls		●
	Automatic lighting via detectors (indoors)	●	●
	Automatically dim the landing lights at night	●	●
	Automatic front door light		●
	The right music whenever and wherever you like	●	●
	Dim lights	●	●
Switch lights on or off automatically using detectors	●	●	
	Door and window protection with detectors		●
	Fire alarm at home, but also on your smartphone		●
	Panic button	●	●
	Extra movement detectors for alarms	●	●
	Control over your front door (even from a distance)	●	●
	Secret code for activating/deactivating alarm		●
	Automatic ventilation	○	●
	Central heating and hot water only when necessary	○	●
	Central heating only where needed		●
	Control roll-down shutters, sun blinds and curtains	●	●
	Manage your energy consumption	○	●
	Control socket outlets	●	●
	Inform family in an emergency	●	●
	Open the door from your armchair or away from home	●	●
	Automatically switch off household devices	●	●
	Personal alarm button	●	●
	Wireless buttons wherever you like	●	●

○ With traditional wiring, only possible with partner systems (via API connection).  
See which quality partners Niko links with at [www.niko.eu/partners](http://www.niko.eu/partners)



# Simple installation for traditional wiring



## Wireless smart hub for Niko Home Control

The wireless smart hub for Niko Home Control is the brain of the installation. It **centralises all logic and automations**. **Communication also** occurs via the hub. So your customers can always see the correct setting of their devices in the installation.

You connect it to your customers' home network via Ethernet cable supplied. As soon as you've connected it, register it at Niko in the customer's name. Without registration your customers can't control their installation with their smartphone.

Place it in a central location in your customer's home to ensure the best connection. Then all you have to do is plug it in to a free socket outlet.

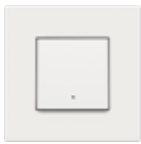

### Connected single and double switch

Place the connected switch in the same location as a traditional switch. It has a switching contact of 10 A and a control button (2 for the 2-fold switch). You can use the switch immediately after installation, without having to configure it.



Do your customers want to control the switch from multiple locations? Then you can expand it with traditional push buttons or with **wireless controls combined with the wireless smart hub**.

Using the wireless smart hub? Then you can terminate the built-in link between the button and the switching contact. This way you can use the button on the device for another function, or connect to a mood, for example.

Example wiring diagram:  
connected single and double switch

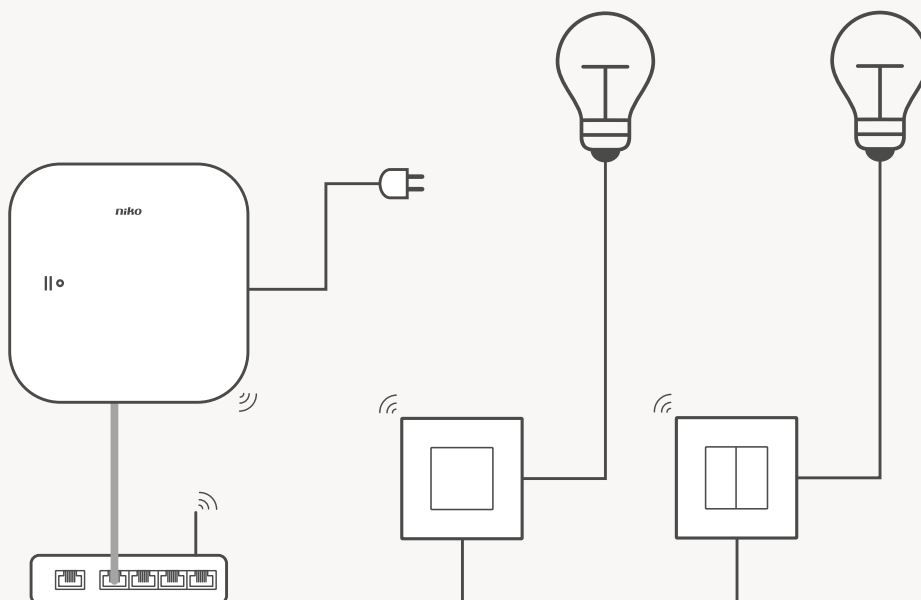

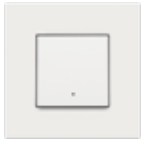

### Connected dimmer

The connected dimmer is a **universal dimmer 2 wire** that is compatible with most lamps. You can use it immediately after installation. You can set preferences on the dimmer, such as the dim profile and minimum dimming level.

Do your customers want to add more functions? In combination with the wireless smart hub, you can also use the dimmer for, among others, **moods** and the **all-off function**.

Do they want to control the connected dimmer from multiple locations? No problem either. Via the **extension clamp**, you can easily add a traditional push button. Using the wireless smart hub? Then you can control it with wireless switches or your smartphone.

Example wiring diagram:  
connected dimmer

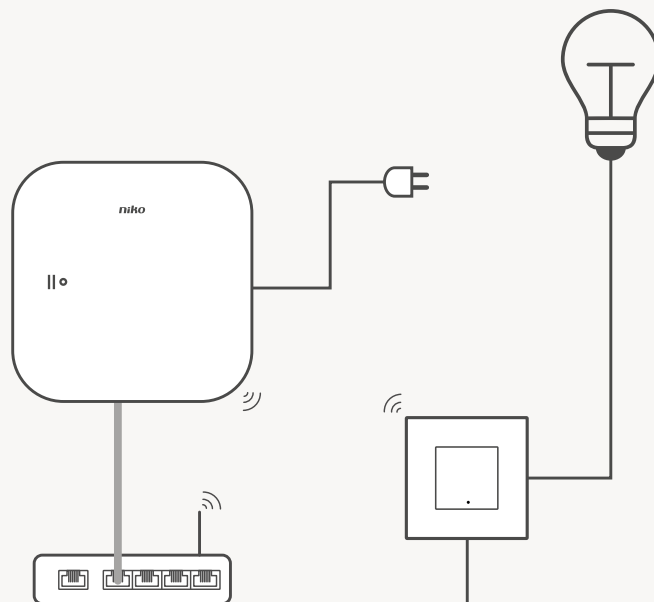



### Connected motor control

You can control every **230V controlled motor** with the connected motor control. Thanks to the 2 switching contacts of each 3 A, the motor control can control almost any roller blind or curtain. Default runtimes are set at 120 seconds. This allows you to control the motor immediately, without any further configuration needed.

Combined with the wireless smart hub, you can include the motor control in functions such as moods and all-off. Do your customers want to control the motor from multiple locations? They can when they combine it with the wireless smart hub and wireless controls. Warning: the connected motor control does not have an output to connect a wired extension.

Example wiring diagram:  
connected motor control

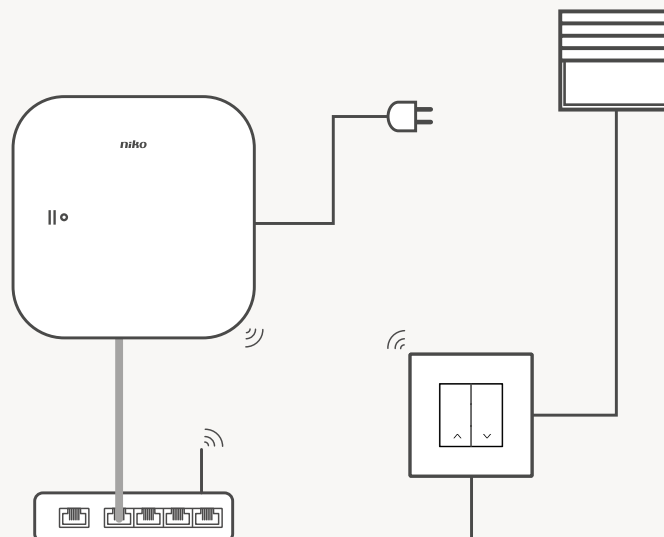



### Connected wireless motion detector

The connected wireless motion detector only works with the wireless hub. They **communicate wireless**. The hub sends your customers' commands to the various actors in the installation. This way, for example, you can use the motion detector to switch the lights on/off automatically in areas your customers don't often use.

Example wiring diagram:  
connected wireless motion detector

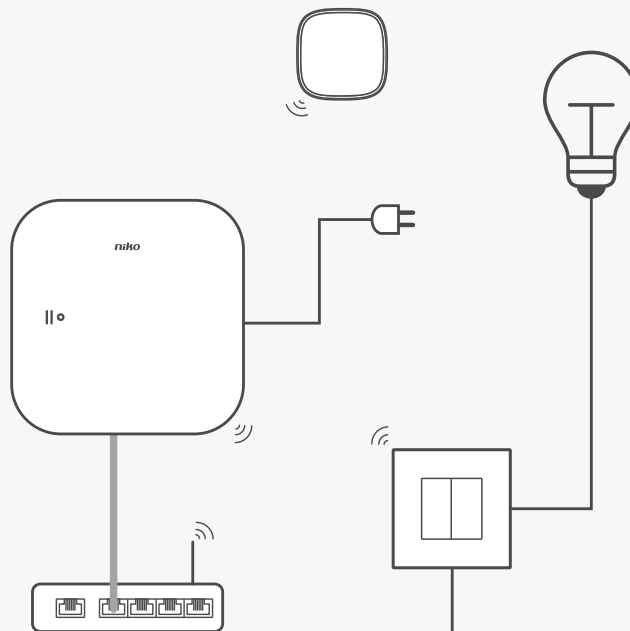







### Connected socket outlet

You turn the connected socket outlet on/off with the built-in push button. When you add the wireless smart hub to the installation, you can also control the socket outlet with other connected switches or wireless controls and include them in moods, all-off and other actions in Niko Home Control. The connected socket outlet switches to 16 A and **measures the amount of electricity that is used by the device that is connected to it**. Your customers can view that consumption in the Niko Home Control app. This way, they see how much a specific device uses and make adjustments if needed.

Example wiring diagram:  
connected socket outlet

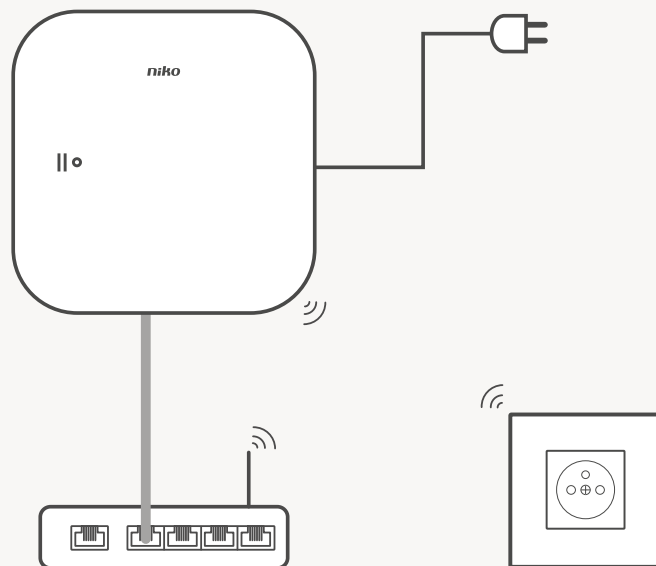

### Wireless controls

You can expand Niko Home Control for traditional wiring **with wireless controls that use the Easywave protocol** (only the 2- and 4-fold push buttons).

To add wireless controls to the installation, you will need a wireless smart hub. You easily configure the functions the wireless controls need in the programming software: expand a connected dimmer, start a mood, all-off, ...





### Touchswitch\*

Control various Niko Home Control controls en atmospheres with this intuitive control screen. You connect the touchswitch for traditional cabling to 230 V AC. The touchswitch has a built-in single switch, which allows you to place it in the same location as a conventional single switch. You can use the touchswitch as a single switch immediately after installation, without having to configure it. And you can even extend it with conventional push buttons. That way, you control the built-in single switch directly from multiple locations. You add the touchswitch to the Niko Home Control installation via the programming software. Afterwards, your customer can configure which functions he wants to control with the screen in the configuration app for smartphones. Does the user want to modify the functions, rearrange the controls or even choose a different way of navigating? He can easily configure the touchswitch with his smartphone. In the Niko Home Control installation for traditional wiring, he can also control his other connected functions with the touchswitch and smartphone.

**Thanks to the Niko touchswitch you can combine the simplicity and easy operation of a normal switch with the flexibility of an adjustable control screen.**

- control your lighting, roll-down shutters, ventilation, music and atmospheres and more with 1 screen.
- up to 12 controls or atmospheres
- digital control no larger than a switch
- simple for the customer to configure with a smartphone
- intuitive control in 1 movement thanks to the proximity sensor
- sharp image quality with large viewing angle allows variable mounting height
- if you have a connection to a smart heating installation from one of our partner brands, then you can easily set the temperature

Example wiring diagram:  
touchswitch

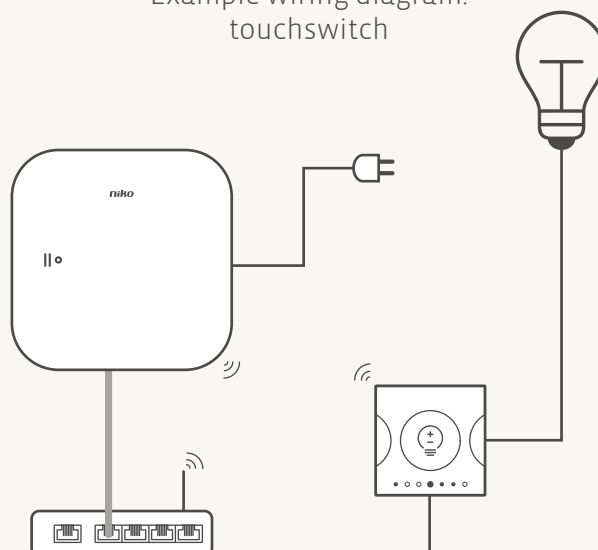



### Touchscreen

You can also add the Niko Home Control touchscreen to an installation for traditional wiring. All **your controls for the entire house in one spot**.

Thanks to the UTP cabling and the Power of Ethernet support, you can connect your touchscreen to the installation and power supply with 1 cable (combined with the Power or Ethernet power supply 550-00502).

Do your customers have an **external video unit** in their installation? Then they can receive the calls from the external unit on the screen of their touchscreen. They can also see the visitors from the past 30 days (maximum 20).

The touchscreen also allows your customers to use moods for which that have not provided a button. It's an alternative to a large number of switches in the home.

Example wiring diagram:  
touchscreen

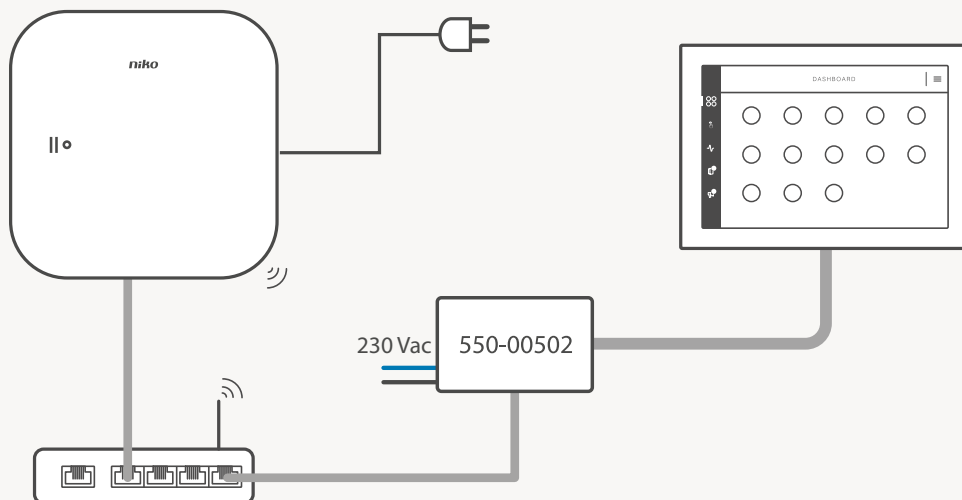



### External video unit

You can also connect the external video unit from Niko Home Control to an installation for traditional wiring. You will need a UTP cable for the communication and power supply (combined with the Power or Ethernet-supply 550-00502).

Do your customers also have a Niko Home Control touchscreen and a smartphone? Then they can receive the calls from the external video unit here as well. This way, they can always see, from anywhere, who is at the door.

Example wiring diagram:  
external video unit

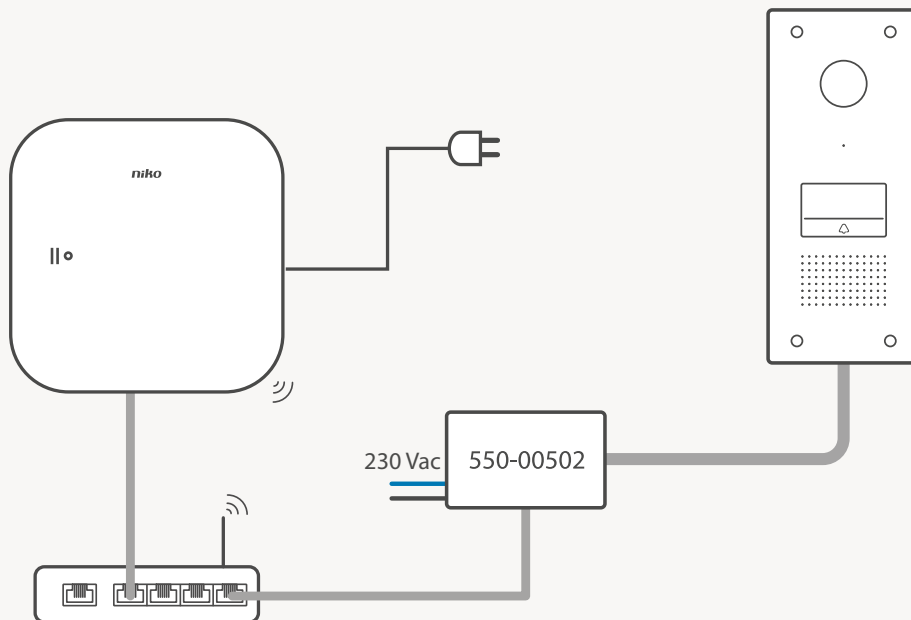





# The possibilities of Niko Home Control for traditional wiring

# Lighting

A house must have good and efficient lighting. Your customers must be able to control their lighting comfortably, without having to try all the switches first. Various new lighting sources have also come onto the market in recent years. New light sources such as these use much less energy than traditional bulbs. This has created a whole new range of possibilities in the field of mood, colour and accent lighting for the home. With Niko Home Control, you can switch and dim every light source in a user-friendly way.



## Lighting with Niko Home Control

### Easy control

- indication LEDs ensure that your customers easily find the control unit in the dark, and indicate whether any of the lights have been left on.
- **user-friendly control:**
  - automatic control via the motion detector
  - central control via touchscreen and touchswitch
  - control via smartphone and tablet
- your customers dim their lighting with 1 button or a dimming control in which they save their preference settings.
- the traditional switches and socket outlets from the existing installation can be replaced without drilling or channelling work with the connected controls from Niko Home Control
- with the programming software, your customers can easily add or adjust new moods or automatic time settings.
- with a **touchswitch** you can even group and modify up to 12 controls with the accompanying configuration app whenever you want

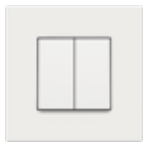

### Saving energy

- effortless connection and dimming of halogen lamps, incandescent lamps, energy-saving LED and economy lamps.
- **ultra-low energy consumption** due to the bistable relays in the switching modules.
- if your customers wonder if they turned off the lights after leaving, then they can check their smartphone to see if they did.



### Lighting control via detectors

Do your customers wish to avoid having to constantly turn the light on and off? Or reduce the electricity consumption of their lighting? Detectors are the perfect solution. You can place the wireless motion detector anywhere inside your home.

### Dimming lights

Place the connected switch in the same location as a traditional switch or dimmer.

You can use the dimmer immediately after installation, without having to configure it.

With the dim module your customers dim:

- incandescent lamps
- 230V halogen lamps
- 12V halogen lamps with ferromagnetic transformer
- 12V halogen lamps with electronic transformer
- dimmable LEDs or LED fittings
- dimmable economy lamps (CFLi)



Example wiring diagram: 6 connected light circuits  
3 switched wall socket outlets and 1 dimmed light circuit

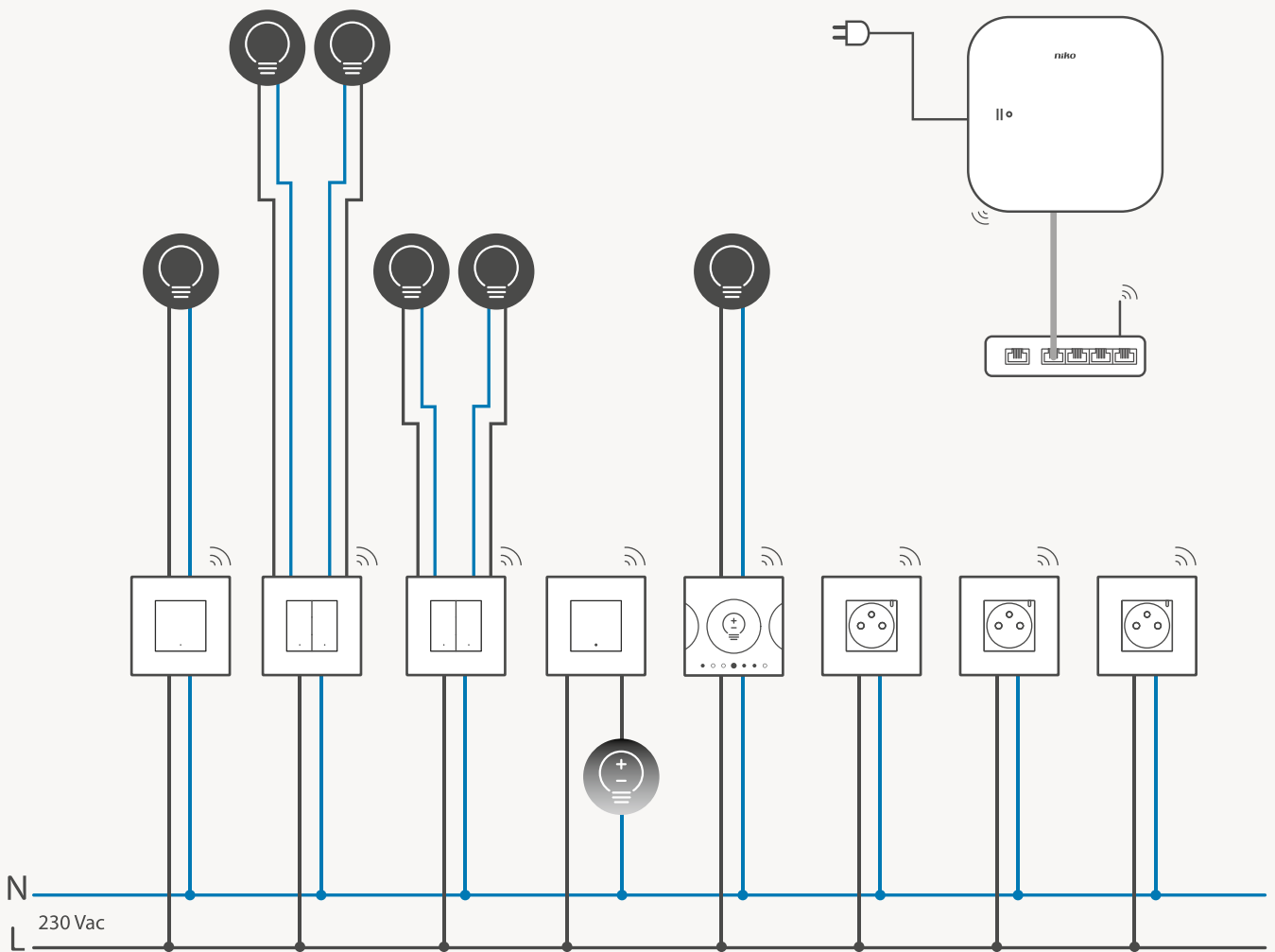

# Control your roll-down shutters, sun blinds and curtains

These days, many houses are fitted with motorised roll-down shutters, sun blinds or curtains. At night, roll-down shutters provide **protection and a feeling of security**, whilst **keeping out unwanted sunlight** during the day. Sun blinds help maintain a **comfortable temperature inside the home** and help reduce **glaring sunlight**. These features are useful, but they require a lot of running back and forth each day. Niko Home Control lets the resident close the roll-down shutters automatically at night while he is away, or roll down the sun blinds automatically when needed. Once again, Niko Home Control addresses the resident's needs.



## Control your roll-down shutters, sun blinds and curtains with Niko Home Control

### Easy control

- **sense of security:**
  - even when the resident is not at home, the roll-down shutters will be closed automatically or the curtains will close, at whichever time and for however long he wants
  - indication LEDs ensure that the resident easily finds the control unit in the dark
- **user-friendly and comfortable control:**
  - automatic control based on calendar settings
  - central control via touchscreen and touchswitch
  - smartphone and tablet, also when you are not at home
  - personal settings possible, e.g. when watching television
- **the compact control units** require minimal space and follow the design of other Niko switching materials
- with the app on their smartphone or tablet, your customers can always set their roll-down shutters and sun blinds in the desired position, wherever they are, so they work seamlessly with their ventilation and air conditioning
- your customers can add or adjust moods or automatic time settings in the programming software



### Saving energy

Automatic operation of sun blinds eliminates the need for energy wasting air-conditioning units. As soon as the heat reaches a certain temperature, the sun blinds are closed, even when no one is at home at the time. This saves energy and prevents the home from becoming too hot.

Example wiring diagram:  
connected motor control

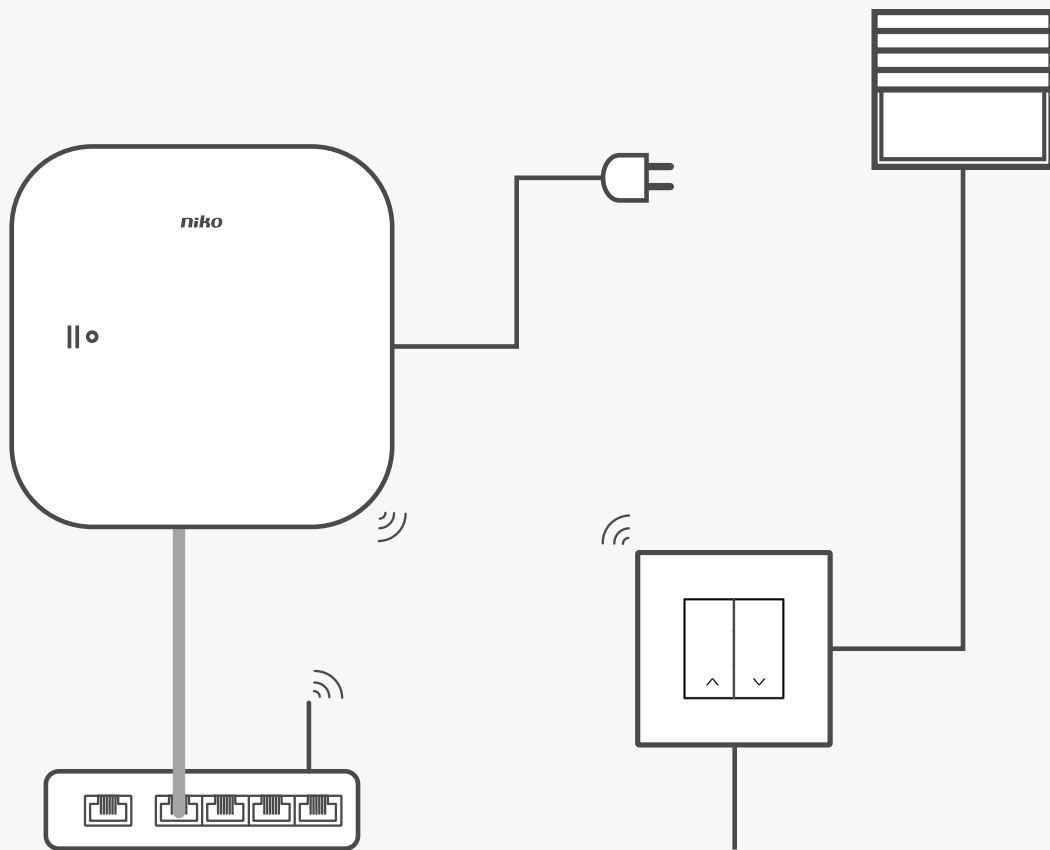

## Control the front door

You decide who to let in without walking to the door and/or front gate. **Access control** is the solution for this. Your customers can see who is at the door on the **touchscreen**. They can talk to their visitors and let them in. And when they come home, they can check the call log book to see who was at the door while they were away. Use their smartphone or tablet as extra internal unit.



### Control the front door with Niko Home Control:

- you only need one Ethernet cable.
- you connect the external video unit directly to the home network
- the control logic is in the wireless smart hub for Niko Home Control

### You connect the external unit and the wireless smart hub for Niko Home Control with a twisted pair cable (UTP, FTP or STP) and RJ45 connectors:

- from external unit to the Power over Ethernet power supply (PoE)
- from the Power over Ethernet power (PoE) to RJ45 port on the home network, you must connect more than 1 device using an Ethernet switch

In the external unit itself, the wires of the cable are placed in the approach terminals.



The wireless smart hub for Niko Home Control receives the function of a SIP server and knows where to send the incoming calls:

- to the touchscreen, via cable.
- and/or to the app on your customers' smartphone or tablet

### Easy control

- **great ease of use**
  - flexible control via the touchscreen, possibly supplemented by a smartphone or tablet.
  - the external unit is equipped with a HD-camera with a 130° detection angle.
  - the camera automatically makes a video recording of everyone who rings the doorbell. This way, your customers can consult missed calls on the touchscreen
  - thanks to the full-duplex speech connection, your customers and their visitors can communicate with each other without having to wait until the other has finished talking.
  - the integrated microphone reduces background noises such as the sounds of a noisy street to a minimum.
  - the touch buttons even respond to gloves: vandalism, damage and wear as was the case with old-fashioned buttons are no longer an issue
  - as soon as someone rings the bell, visitors hear a waiting tune, so they can be certain their visit has been registered
- **very user-friendly**
  - the access control is completely integrated into Niko Home Control.
  - the user interface on the touchscreen and the app make it easy for your customers; via the 'access control' they can talk to their visitors, let them in, adapt the volume, open the door and/or gate ...
- **contemporary design**
  - the external video unit fits seamlessly with the Niko Home Control design
  - the design is sleek, flat and modern
  - a simple, pleasant shape with flat touch buttons which form a whole with the front plate
  - the engraved name and doorbell symbol are subtly and homogeneously lit
  - the design won a Red Dot Design Award

Example wiring diagram:  
external video unit with single touch buttons

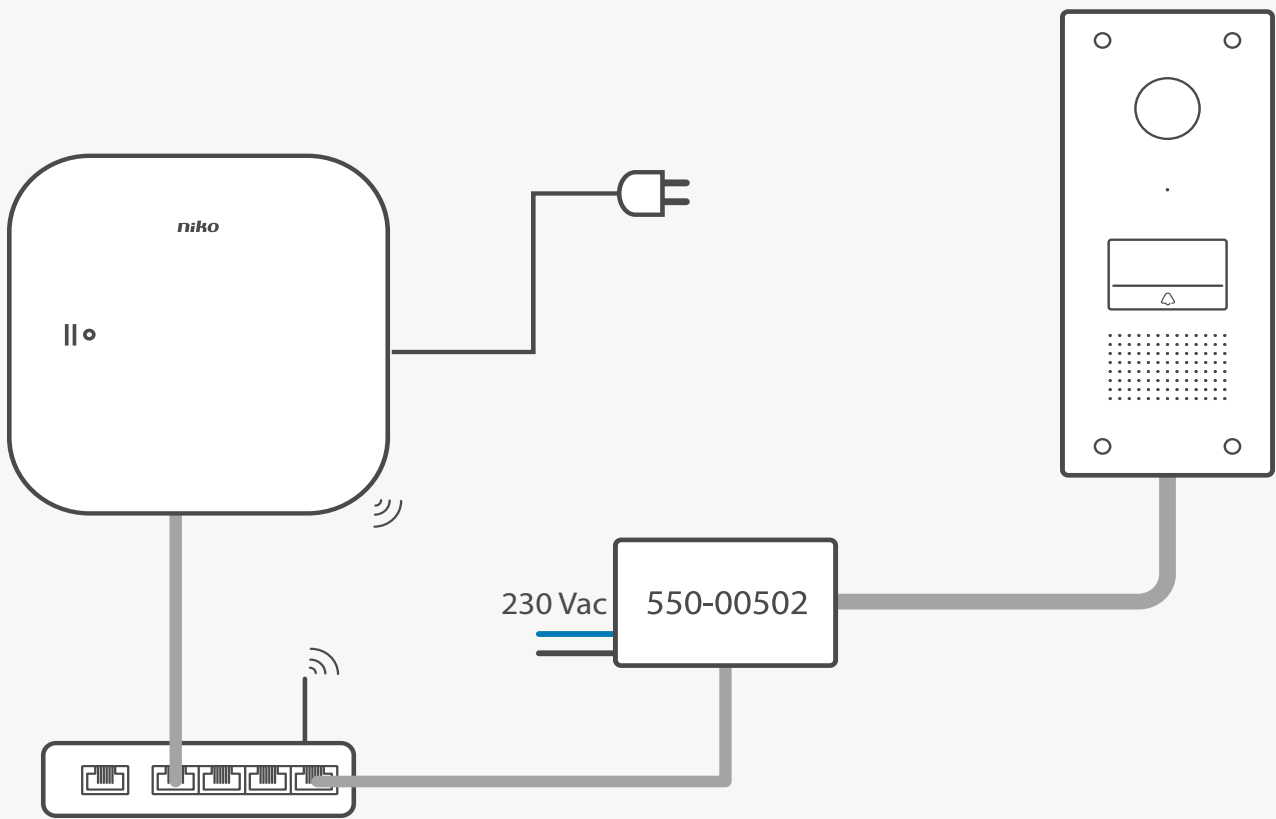



## Living safely

You want to feel safe and secure in your own home. Yet, there are still many things that can potentially go wrong. And if there is any movement while you are not at home, you want to know as soon as possible. **Niko Home Control helps your customers feel safe.**



### Living safely with Niko Home Control

- thanks to the **presence simulation**, it seems like someone is always present at your customers' home: when it's dark every once in a while a light switches on, the roll-down shutters open and shut automatically mornings and evenings...
- **motion detectors** can also send an alert to your customers' smartphone
- with **orientation lighting** in the hallway or on the stairs, they can walk around the house safely at night without switching on the light
- connections with an **external video unit**: your customers decide themselves who they let in, even when they're not home
- with a panic button in the bedroom, your customers can turn on all the lights at night if they hear something suspicious



### Easy control

Your customers activate the presence simulation with the same button they use to put their home in eco-setting. Are they on holiday or having a night out? With one click on their smartphone or tablet they:

- check if they forgot to turn off devices, and if so, turn them off
- control their roll-down shutters or activate the presence simulation
- see where and when motion was detected inside the home
- see who is at the door, talk to their visitors and let them in



### Saving energy

- your customers can choose to use only economy lamps for the presence simulation
- with the **all-off button**, they can switch off all devices which do not need to remain on at once

## Audio control



Do your customers have friends visiting? With one push of a button they set the lights at the correct level, the ventilation a setting higher and start the music on their favourite playlist. With the all-off button, they turn off the music automatically. And if a thief should happen to break in? They can scare him away by playing the music at top volume.



### Audio control with Sonos and Bose

Connect Sonos or Bose audio installations to Niko Home Control. Your customers now control their sound systems with the Niko Home Control installation. And they add the smart solutions from Sonos or Bose to Niko Home Control.

Choose the best solution for your customers	Sonos	Bose
Start & stop music	●	●
Volume higher/lower	●	●
Music off with the all-off button	●	●
Play music with alarm	●	●

The functionalities available depend on the specific type of installation and configuration of the partner system.

#### You will need the following:

- Niko Home Control with programming software version 2.1 onwards
- any Sonos device or a compatible Bose device (Soundtouch 10, 20 or 30)
- network connection for both your Niko Home Control and your audio installation (wired or wireless)

#### Conditions

You must connect Niko Home Control and the Sonos or Bose audio systems to the same home network.



Sample wiring diagram:  
audio control with Sonos and Bose

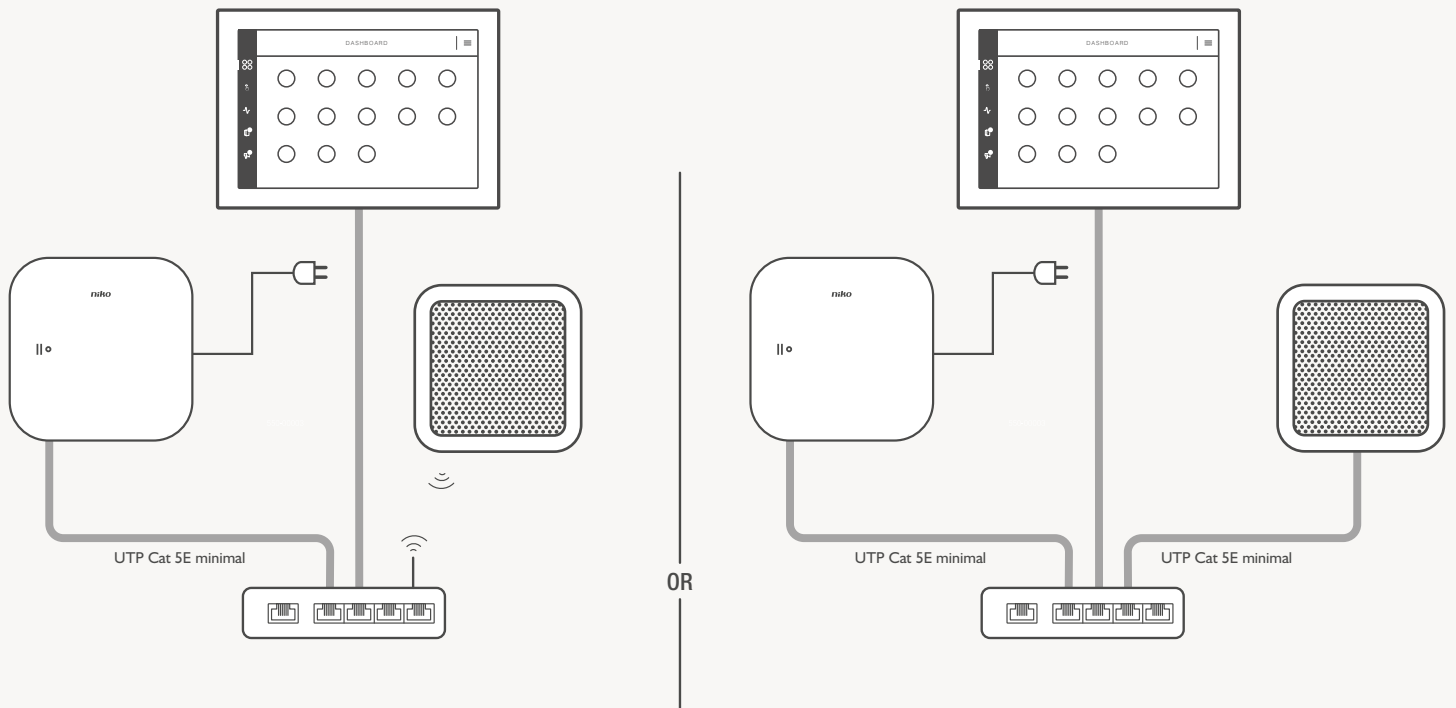

**SONOS**  
THE WIRELESS HI-FI SYSTEM

**BOSE**  
Better sound through research.

# Heating

Your living room is used at different times from your kitchen or bathroom. Children use their bedrooms after school to play and study. Not all the rooms in your customers' homes need to be heated at the same moment. With Niko Home Control, you can heat your customers' homes comfortably and energy-efficiently.



## Heating with NIBE, Mitsubishi, Vaillant, Bulex and Saunier Duval

To control heating systems from NIBE, Mitsubishi, Vaillant, Bulex or Saunier Duval, you must connect the Niko Home Control installation and the partner systems to the same home network.



To allow Niko Home Control to communicate with the systems from NIBE, Mitsubishi, Vaillant, Bulex or Saunier Duval, you must enter the user account details from the partner system at <https://mynikohomecontrol.niko.eu>. After you've done this, the wireless smart hub for Niko Home Control will begin to communicate with the partner system and you can also create complex actions.

### You will need the following:

- Niko Home Control with the most recent programming software
- a compatible heating system from NIBE, Mitsubishi, Vaillant, Bulex or Saunier Duval (go to [www.niko.eu/partners](http://www.niko.eu/partners) for the latest overview of our partners)
- network connection for both your Niko Home Control and your heating system (wired or wireless)

### Conditions

For some brands, Niko Home Control must be connected to the same network as your heating system, go to [www.niko.eu/partners](http://www.niko.eu/partners) to see which systems this applies to. To control the heating system in the mobile app/ touchscreen, you must activate it via <https://mynikohomecontrol.niko.eu>. You can do this by entering the user account that was created by the partner (username and password).

### Easy control

- allows your customers to modify the settings of the various programmes to suit their personal needs
- automatic heating control: your customers don't need to walk through the whole house to turn the thermostatic tap
- more comfort thanks to control via the app: with 1 touch of their smartphone or tablet your customers can set the heating a degree higher before going to work so they never have to come home to a cold house

### Saving energy

Preventing the energy-wasting air conditioning from starting up constantly to cool down the house? As soon as it gets too warm, the sun blinds closes automatically. Even if your customer is not at home. They save energy and prevent the home from becoming too hot.

Example wiring diagram:  
heating with NIBE, Mitsubishi, Vaillant, Bulex and Saunier Duval

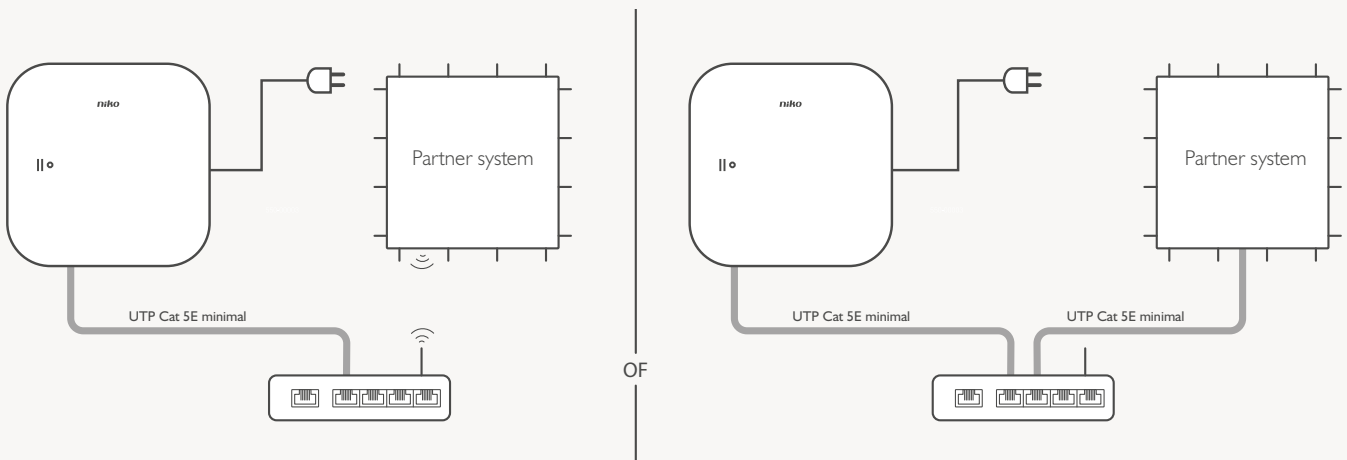

Choose the best solution for your customers	NIBE	Mitsubishi	Vaillant	Bulex	Saunier Duval
Control your room temperature		●	●	●	●
See your temperature indoors and outdoors	●	●	●	●	●
Choose the heating mode (away, home, ...)	●	●	●	●	●
See your domestic hot water temperature	●	●	●	●	●
Boost your domestic hot water system	●	●	●	●	●

## Energy management



Our energy provision changes rapidly. Energy is being produced in a much more sustainable way, and we must increasingly reduce our CO<sub>2</sub> emissions.

By using smart switches for lighting, heating, connected socket outlets, ventilation and other installations, Niko Home Control ensures that your customers have the **lowest possible energy consumption**. That is good for the environment and their wallet.



Niko Home Control helps your customers make **optimum use of the solar energy they produce themselves**. This means they become less dependent on the energy provider. When energy is needed, Niko Home Control uses as much energy as possible from your customers' own solar panels. Because often more than 70% of the energy they produce themselves flows back into the network. And they need to use it at a later time. With this application, your customers are ready for the future smart meter.



Niko Home Control also makes sure all devices are working properly, 24/7. Niko Home Control notices an extremely high energy consumption or that the solar panels aren't working? Then your customers will be **notified immediately**.

### Energy management with Smappee

Connect the Smappee energy management system to Niko Home Control. This way, your customers see the consumption details that Smappee collects in their Niko Home Control installation. And they add the smart solutions from Smappee to Niko Home Control. All information is conveniently located on the Niko Home Control dashboard.

To measure energy with Smappee, you must connect both Niko Home Control and Smappee to the same home network. Niko Home Control detects the installation automatically. The information also appears automatically in Niko Home Control.

#### You will need the following:

- Niko Home Control with the most recent programming software
- a compatible Smappee energy system (go to [www.niko.eu/partners](http://www.niko.eu/partners) for the latest overview of our partners)
- network connection for both your Niko Home Control and your energy system (wired or wireless)

#### Conditions

For some brands, Niko Home Control must be connected to the same network as your heating system, go to [www.niko.eu/partners](http://www.niko.eu/partners) to see which systems this applies to. To control the heating system in the mobile app/touchscreen, you must activate it via <https://mynikohomecontrol.niko.eu>. You can do this by entering the user account that was created by the partner (username and password).

#### Easy control

The touchscreen and the app display the current and past gas, water and electricity consumption. The app is available for smartphones and tablet with iOS or Android operating system.

## Example wiring diagram: energy management with Smappee

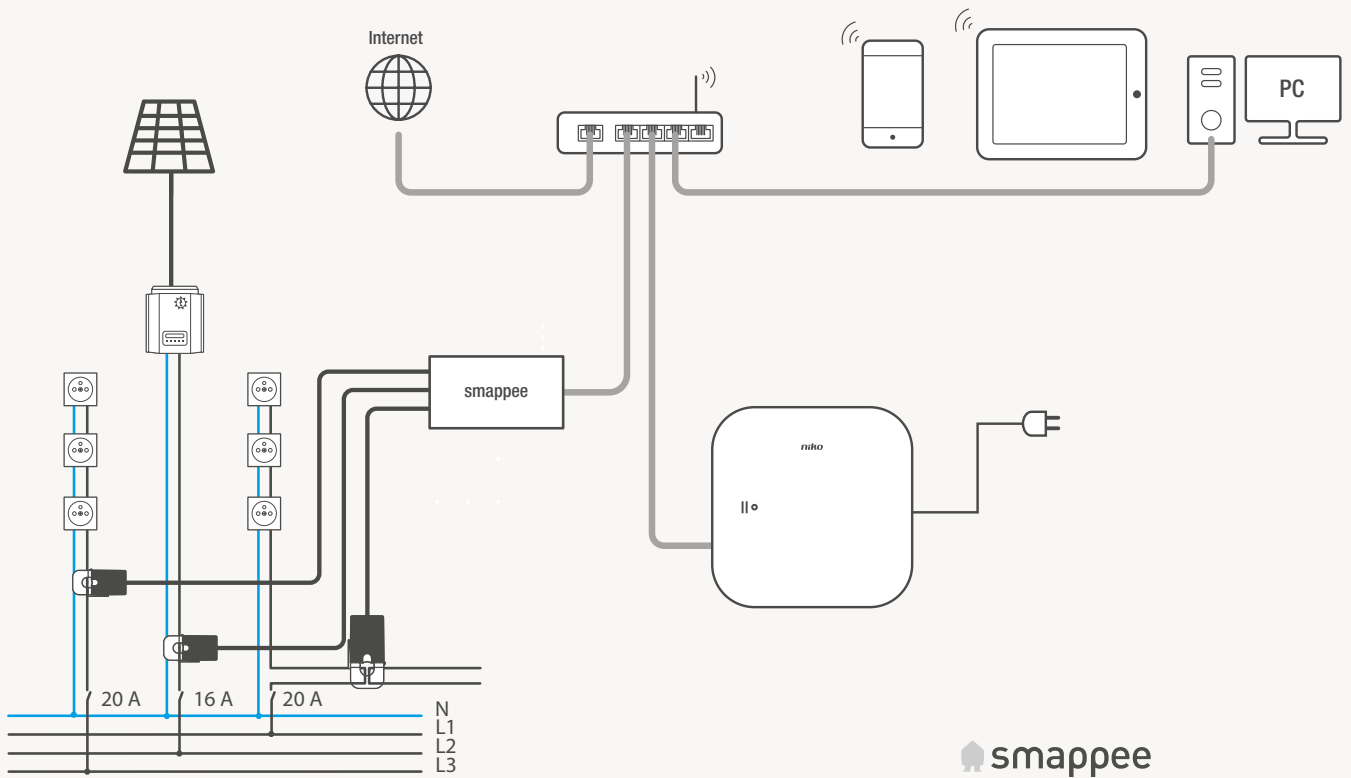

 smappee

Choose the best solution for your customers

Smappee

Insight into electricity consumption



Insight into electricity production



# Ventilation

A ventilation system provides a healthy indoor climate. Your customers waste less energy than when they regularly open the windows. Unfortunately, even ventilation systems create energy loss. By extracting hot air, part of the heating capacity is lost. In new homes, this translates into a heat loss of 20 to 25%. Electricity consumption during ventilation is a main reasons why you should opt for smart ventilation control. This way, the ventilation only runs when needed and your customers will not waste energy.



## Ventilation with Renson, Duco and NIBE

Connect a Renson, Duco or NIBE ventilation system to Niko Home Control. Your customers can then control these brands with Niko Home Control and add their ventilation system's smart solutions to Niko Home Control.

In order to control our partners' ventilation system, you must connect your Niko Home Control and the partner systems to the same home network.

To allow Niko Home Control to communicate with the partner systems, you must enter the user account details from the partner system at <https://mynikohomecontrol.niko.eu>. After you've done this, the wireless smart hub for Niko Home Control will begin to communicate with the partner system and you can also create complex actions.

### You will need the following:

- Niko Home Control with the most recent programming software
- a compatible ventilation system from Renson, Duco or NIBE  
(go to [www.niko.eu/partners](http://www.niko.eu/partners) for the latest overview of our partners)
- network connection for both your Niko Home Control and your ventilation system (wired or wireless)

### Conditions

For some brands, Niko Home Control must be connected to the same network as your heating system, go to [www.niko.eu/partners](http://www.niko.eu/partners) to see which systems this applies to. To control the heating system in the mobile app/ touchscreen, you must activate it via <https://mynikohomecontrol.niko.eu>. You can do this by entering the user account that was created by the partner (username and password).

Example wiring diagram:  
ventilation with Renson, Duco and NIBE

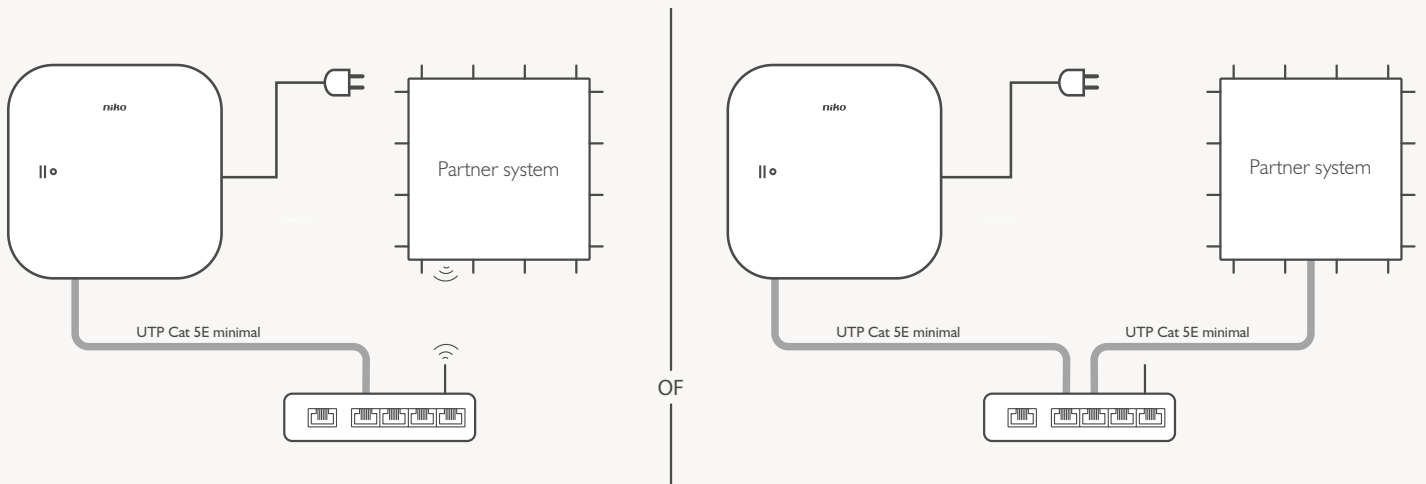

Choose the best solution  
for your customers

	Renson	Duco	NIBE
Control your ventilation speed	●	●	●
Control your ventilation mode (away, home,...)		●	
See your CO2 level and Relative Humidity		●	
See your Airquality Index	●		
Boost your ventilation	●	●	●

# GROUNDBREAKING NOT WALL BREAKING



Complete control for  
every home, every time.









# The Niko Academy

## We help you to be the best installer with Niko Home Control

### Better installation, better service

Want to discover just how easy it is to install and program Niko Home Control? Would you also like to learn about the possibilities and how to use them creatively? Complete one of our Niko Home Control training courses

### Practical training courses

Niko ensures that you can help your customers like a true expert. Our training courses are free of charge and practice oriented. You choose where you want to take them: online or in one of our training centres: in Sint-Niklaas for courses in Dutch and in Mons or Seraing for courses in French.

### Personal coaching?

Choose a training course in one of our training centres? You will receive personal coaching in small groups of up to 10 people. A professional trainer will give you handy tips, practical advice and an answer to all your questions. This way you can put theory into practice along with other professionals. You don't need to bring anything: we provide everything you need.

### Offer

Are you interested in a training on Home Control for traditional wiring? Keep an eye on our training page for the dates [www.niko.eu/training](http://www.niko.eu/training).

#### Would you like to enrol?

Due to the large amount of interest, our training courses are only available to professionals. This is why we request you to register via your **myNiko**-account. Don't have an account yet? Create one **free** at [my.niko.eu](http://my.niko.eu).

#### Want to find out more about the Niko Home Control training courses?

More information can be found on [www.niko.eu/training](http://www.niko.eu/training). Or send an email ([training@niko.eu](mailto:training@niko.eu)) or call us at **03 778 92 43**. We'll be delighted to help you.



# Niko Home Control online

## Website

You can find more information about Niko Home Control on our website on the Niko Home Control page for professionals. This allows you to provide your customer with all necessary information. Here you'll find an overview of our products, information about our showroom, the partner systems you connect Niko Home Control to,... You can also download our brochures there, or have them sent to you free of charge.

More information can be found on [www.niko.eu](http://www.niko.eu).

## Registration

Have your customers register their installation on <https://mynikohomecontrol.niko.eu> so that you can offer them better support together with Niko

in the case of problems and so they can receive important updates for their system. This registration is also necessary in order to activate the control with smartphone and/or tablet.

## My Niko

My Niko is your place to be:

- register for Niko Home Control training courses
- you will receive customised information: events, commercial promotions and useful tips
- you register for the Niko Partner Program
- always an overview of your support requests
- keep your personal details up-to-date

More information can be found on [www.niko.eu/myNiko](http://www.niko.eu/myNiko).

## Niko Partner Program

Installers receive special treatment at Niko. Take the Niko Home Control training course and register for the Niko Partner Program. The advantages?

- after a few installations, Niko will promote you to recognised Niko Home Control installer.
- you will be among the first to be informed of software updates and new products.
- per installation and additional training you earn points for nice gifts from our online shop.

More information can be found on [www.niko.eu/myNiko](http://www.niko.eu/myNiko).

## Software manual

The online manual familiarising you step-by-step with the Niko Home Control installation. You can find information on the basic functions, frequently used programmings, the cabinet lay-out and the actual installation. It is a useful guide after the training or during the installation. You can also download and print the software manual. Surf to [guide.niko.eu](http://guide.niko.eu).

# Flush surround plates

## Niko Pure

Do you love an **ultra-sleek design** in timeless materials? Then you will love the refined look of Niko Pure. A series made from **special materials full of character and emotion**, including bamboo, stainless steel, Bakelite and Plexiglas. Your guarantee of an **elegant and sustainable finish**. Affordable leading design.



liquid snow white



white steel



stainless steel on white



champagne steel



alu gold



natural soft grey



alu grey



stainless steel on anthracite



bamboo

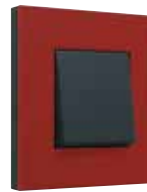

natural red



alu steel grey



alu black



black steel



Bakelite® piano black

### Trendy finishes



dark bamboo on gold



dark bamboo on anthracite

## Niko Intense

Niko Intense, a series that you need to feel. Niko Intense is all about touch. The **sleek shape** and **soft lines** radiate intensity. With these switches, you are choosing a distinctly **warm character**.



white



sterling



bronze



dark brown



anthracite

## Niko Original

Are you attracted to **soft lines** and **mild colours**? Then Niko Original is just what you are looking for. You are choosing a finish with a **discreet** presence.



white



cream



light grey



greige

With the **Niko Switch app**, you can check to ensure your favourite switch **complements your interior**.  
[www.niko.eu/switch-niko-app](http://www.niko.eu/switch-niko-app)

Discover all of the products **for yourself** at the **Niko Inspiration Center** in Antwerp.  
[www.niko.eu/showroom](http://www.niko.eu/showroom)







Ready to choose?



Download the Switch Niko app in the App Store or Google Play. The contrasting Niko image is available on:  
[www.niko.eu/switch-niko-app](http://www.niko.eu/switch-niko-app).







# Product overview Niko Home Control for traditional wiring



NEW

### Touchswitch, connected customisable control screen, 230 V

Touchswitch is a completely customisable touchscreen which has an extremely user-friendly interface with clear symbols. The screen is automatically activated when your hand comes near, so you can switch or dim your lights, set moods, set ventilation modes, adjust the temperature, adjust blinds and sun blinds to the desired position, in one operation. In short, all possible types of controls are available in your Niko Home Control system. With the corresponding configuration app not only can you choose which controls are displayed or where they are displayed on the screen, but also the way you navigate through your control screens. You can download this app for free in the respective app store for your mobile device.

The screen can be easily mounted in any standard flush-mounting box using the familiar screw fixing, and is powered on 230 V AC. This 230 V AC variant is equipped with a switching contact 10 A (resistive), meaning that it can easily be replaced with a conventional single-pole switch. In combination with the wireless smart hub for Niko Home Control (552-00001) and additional connected control points from the Niko Home Control range for conventional wiring, you can easily add additional automation to your conventional installation.

The screen communicates via your wireless home network with the rest of your Niko Home Control system. You need an active internet connection to activate and register the screen. This internet connection ensures that your screen and Niko Home Control installation are always up-to-date, and have the most recent functionalities.

- recommended mounting height: 110 - 160 cm
- power supply voltage: 230 V AC  $\pm$  10 %, 50 Hz
- WiFi: 2.4 GHz bgn
- ambient temperature: 0 - 40 °C
- proximity sensor: 0 – 30 cm
- light sensor for automatic adjustment of the screen intensity
- maximum number of touchswitches in one installation: 10
- screen size: 3.6"
- screen resolution: 1024 x 768
- screen dimensions: 83 x 83 x 11.5 mm (HxWxD)
- dimensions flush-mounting mechanism: 45,7 x 49,6 x 31,7 mm (HxWxD)
- protection degree: IP20
- CE marked

**Available in the second quarter of 2020**



#### COMPLETE UNIT

- |                  |           |   |
|------------------|-----------|---|
| <b>551-18000</b> | Pieces: 1 | With plug-in terminals and claw fixing  |
| <b>551-18001</b> | Pieces: 1 | With plug-in terminals and screw fixing |

### Connected single switch, 10 A

The connected single switch has a switching contact to switch lighting. It contains a transmitter and receiver that can communicate wirelessly with the wireless smart hub for Niko Home Control.

You can use the connected single switch to replace a conventional switch. It is equipped with an extension terminal so that, in combination with a conventional push button, it can easily replace multiway or intermediate switching.

The connected single switch can switch its own contact.

Once connected to the wireless smart hub for Niko Home Control, it is possible to configure additional functionalities with the Niko Home Control programming software. For example, you can add the switch to a mood or all-off function.

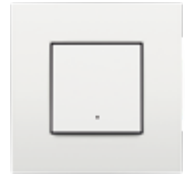

It is possible to disconnect the control from its built-in contact. That way, you have complete flexibility to configure the switching contact and the controls separately via the programming software.

















NEW

- power supply: 230 Vac
- protocol: proprietary
- mounting method: wall mounting
- mounting height: 110 - 120 cm
- modification of settings: Niko Home Control programming software (requires smart hub 552-00001)
- maximum range (from switch to smart hub): 30 m
- operating frequency: 869,05 Mhz
- maximum frequency power: 6 dBm
- LED colour: white
- protection degree: IP20
- flush-mounting depth: 40 mm
- ambient temperature: 0 – +40 °C
- marking: CE







#### BASE

	<b>551-72101</b>	Pieces: 6	Connected single switch, base, claw fixing
	<b>551-72111</b>	Pieces: 6	Connected single switch, base, screw fixing, centre distance 71 mm
	<b>551-72121</b>	Pieces: 6	Connected single switch, base, screw fixing

#### FINISHING SET WITH LENS

	<b>100-32002</b>	Pieces: 10		<b>101-32002</b>	Pieces: 10		<b>102-32002</b>	Pieces: 10
	<b>104-32002</b>	Pieces: 10		<b>121-32002</b>	Pieces: 10		<b>122-32002</b>	Pieces: 10
	<b>123-32002</b>	Pieces: 10		<b>124-32002</b>	Pieces: 10		<b>154-32002</b>	Pieces: 10
	<b>157-32002</b>	Pieces: 10		<b>161-32002</b>	Pieces: 10		<b>200-32002</b>	Pieces: 10
	<b>220-32002</b>	Pieces: 10		<b>221-32002</b>	Pieces: 10			

#### FINISHING SET

	<b>100-31002</b>	Pieces: 10		<b>101-31002</b>	Pieces: 10		<b>102-31002</b>	Pieces: 10
	<b>104-31002</b>	Pieces: 10		<b>121-31002</b>	Pieces: 10		<b>122-31002</b>	Pieces: 10
	<b>123-31002</b>	Pieces: 10		<b>124-31002</b>	Pieces: 10		<b>154-31002</b>	Pieces: 10
	<b>157-31002</b>	Pieces: 10		<b>161-31002</b>	Pieces: 10		<b>200-31002</b>	Pieces: 10
	<b>220-31002</b>	Pieces: 10		<b>221-31002</b>	Pieces: 10			

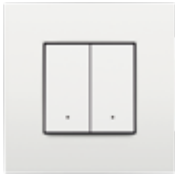

**Connected double switch, 2 x 10 A (total max. 16 A)**

The connected double switch has a switching contact to switch lighting. It contains a transmitter and receiver that can communicate wirelessly with the wireless smart hub for Niko Home Control.

You can use the connected double switch to replace a conventional switch. It is equipped with an extension terminal so that, in combination with a conventional push button, it can easily replace multiway or intermediate switching.

The connected double switch can switch its own contact.

Once the wireless smart hub for Niko Home Control has been added, it is possible to configure additional functionalities with the Niko Home Control programming software. That way, it is possible to connect these in a mood or all-off function and much more.

It is possible to disconnect the control from its built-in contact. That way, you have complete flexibility to configure the switching contact and the controls separately via the programming software.

- power supply: 230 Vac
- protocol: proprietary
- mounting method: wall mounting
- mounting height: 110 - 120 cm
- modification of settings: Niko Home Control programming software (requires smart hub 552-00001)
- maximum range (from switch to smart hub): 30 m
- operating frequency: 869,05 Mhz
- maximum frequency power: 6 dBm
- LED colour: white
- protection degree: IP20
- flush-mounting depth: 40 mm
- ambient temperature: 0 – +40 °C
- marking: CE

**BASE**



**551-72102** Pieces: 6 Connected double switch



**551-72112** Pieces: 6 Connected double switch, screw fixing, centre distance 71 mm



**551-72122** Pieces: 6 Connected double switch, screw fixing

**FINISHING SET WITH LENS**



	<b>100-32004</b>	Pieces: 10		<b>101-32004</b>	Pieces: 10		<b>102-32004</b>	Pieces: 10
	<b>104-32004</b>	Pieces: 10		<b>121-32004</b>	Pieces: 10		<b>122-32004</b>	Pieces: 10
	<b>123-32004</b>	Pieces: 10		<b>124-32004</b>	Pieces: 10		<b>154-32004</b>	Pieces: 10
	<b>157-32004</b>	Pieces: 10		<b>161-32004</b>	Pieces: 10		<b>200-32004</b>	Pieces: 10
	<b>220-32004</b>	Pieces: 10		<b>221-32004</b>	Pieces: 10			

**FINISHING SET**



	<b>100-31004</b>	Pieces: 10		<b>101-31004</b>	Pieces: 10		<b>102-31004</b>	Pieces: 10
	<b>104-31004</b>	Pieces: 10		<b>121-31004</b>	Pieces: 10		<b>122-31004</b>	Pieces: 10
	<b>123-31004</b>	Pieces: 10		<b>124-31004</b>	Pieces: 10		<b>154-31004</b>	Pieces: 10
	<b>157-31004</b>	Pieces: 10		<b>161-31004</b>	Pieces: 10		<b>200-31004</b>	Pieces: 10
	<b>220-31004</b>	Pieces: 10		<b>221-31004</b>	Pieces: 10			

### Connected dimmer, 3 - 200 W, 2-wire

The connected dimmer contains a dimmer contact to control the lighting. It contains a transmitter and receiver that communicate wirelessly with the wireless smart hub for Niko Home Control.

You can use the connected dimmer to replace a conventional switch. It is equipped with an extension terminal so that, in combination with a conventional push button, it can easily replace multiway or intermediate switching.

The connected dimmer can switch its own contact.

With the addition of the wireless smart hub for Niko Home Control, it is possible to configure additional functionalities with the Niko Home Control programming software. For example, it becomes possible to add it to a mood or all-off function.

It is possible to disconnect the control from its built-in contact. That way, you have complete flexibility to configure the switching contact and the controls separately via the programming software.

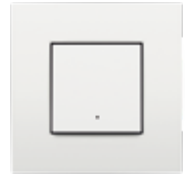

NEW

- Power supply: 230 Vac
- Protocol: proprietary
- Mounting method: wall mounting
- Mounting height: 110 - 120 cm
- Modification of settings: Niko Home Control programming software (requires smart hub 552-00001)
- Maximum range (from switch to smart hub): 30 m
- Operating frequency: 869,05 Mhz
- Maximum frequency power: 6 dBm
- LED colour: white
- Protection degree: IP20
- Flush-mounting depth: 40 mm
- Marking: CE

#### BASE

	<b>551-72201</b>	Pieces: 6	Connected dimmer, 3 – 200 W, claw fixing
	<b>551-72211</b>	Pieces: 6	Connected dimmer, screw fixing, centre distance 71 mm
	<b>551-72221</b>	Pieces: 6	Connected dimmer, 3 - 100 W, screw fixing

#### FINISHING SET WITH LENS

	<b>100-32002</b>	Pieces: 10		<b>101-32002</b>	Pieces: 10		<b>102-32002</b>	Pieces: 10
	<b>104-32002</b>	Pieces: 10		<b>121-32002</b>	Pieces: 10		<b>122-32002</b>	Pieces: 10
	<b>123-32002</b>	Pieces: 10		<b>124-32002</b>	Pieces: 10		<b>154-32002</b>	Pieces: 10
	<b>157-32002</b>	Pieces: 10		<b>161-32002</b>	Pieces: 10		<b>200-32002</b>	Pieces: 10
	<b>220-32002</b>	Pieces: 10		<b>221-32002</b>	Pieces: 10			

#### FINISHING SET

	<b>100-31002</b>	Pieces: 10		<b>101-31002</b>	Pieces: 10		<b>102-31002</b>	Pieces: 10
	<b>104-31002</b>	Pieces: 10		<b>121-31002</b>	Pieces: 10		<b>122-31002</b>	Pieces: 10
	<b>123-31002</b>	Pieces: 10		<b>124-31002</b>	Pieces: 10		<b>154-31002</b>	Pieces: 10
	<b>157-31002</b>	Pieces: 10		<b>161-31002</b>	Pieces: 10		<b>200-31002</b>	Pieces: 10
	<b>220-31002</b>	Pieces: 10		<b>221-31002</b>	Pieces: 10			



NEW

**Connected motor control, 2 x 3 A**

The connected motor control contains a switching contact to control a 230V motor. It contains a transmitter and receiver that communicate wirelessly with the wireless smart hub for Niko Home Control.

You can use the connected motor control to replace a conventional motor control.

The connected motor control can switch its own contacts.

With the addition of the wireless smart hub for Niko Home Control, it is possible to configure additional functionalities with the Niko Home Control programming software. For example, it becomes possible to add it to a mood or all-off function.

- power supply: 230 Vac
- protocol: proprietary
- mounting method: wall mounting
- mounting height: 110 - 120 cm
- modification of settings: Niko Home Control programming software (requires smart hub 552-00001)
- maximum range (from switch to smart hub): 30 m
- operating frequency: 869,05 Mhz
- maximum frequency power: 6 dBm
- LED colour: white
- protection degree: IP20
- flush-mounting depth: 40 mm
- ambient temperature: 0 – +40 °C
- marking: CE

**BASE**



**551-72301** Pieces: 6 Connected motor control, claw fixing



**551-72311** Pieces: 6 Connected motor control, screw fixing, centre distance 71 mm



**551-72321** Pieces: 6 Connected motor control, screw fixing

**FINISHING SET**



	<b>100-31006</b>	Pieces: 10		<b>101-31006</b>	Pieces: 10		<b>102-31006</b>	Pieces: 10
	<b>104-31006</b>	Pieces: 10		<b>121-31006</b>	Pieces: 10		<b>122-31006</b>	Pieces: 10
	<b>123-31006</b>	Pieces: 10		<b>124-31006</b>	Pieces: 10		<b>154-31006</b>	Pieces: 10
	<b>157-31006</b>	Pieces: 10		<b>161-31006</b>	Pieces: 10		<b>200-31006</b>	Pieces: 10
	<b>220-31006</b>	Pieces: 10		<b>221-31006</b>	Pieces: 10			

**FINISHING SET WITH LENS**



	<b>100-32006</b>	Pieces: 10		<b>101-32006</b>	Pieces: 10		<b>102-32006</b>	Pieces: 10
	<b>104-32006</b>	Pieces: 10		<b>121-32006</b>	Pieces: 10		<b>122-32006</b>	Pieces: 10
	<b>123-32006</b>	Pieces: 10		<b>124-32006</b>	Pieces: 10		<b>154-32006</b>	Pieces: 10
	<b>157-32006</b>	Pieces: 10		<b>161-32006</b>	Pieces: 10		<b>200-32006</b>	Pieces: 10
	<b>220-32006</b>	Pieces: 10		<b>221-32006</b>	Pieces: 10			



NEW

**Wireless smart hub for Niko Home Control**

The wireless smart hub for Niko Home Control is the brain of the installation. It allows you to connect all connected devices in your installation to the system. Once you have added them, you can easily control them with your smartphone. With the programming software, you can also add extensive functionalities such as moods, all-off actions or presence simulation. The smart hub always needs to be used in combination with the Niko Home Control programming software.

- fitted with a LED indicating the correct functioning of the device
- dimensions (HxWxD): 124 x 124 x 30 mm
- maximum consumption: 6 W
- input voltage: 5 V via power adapter
- RJ45 port, 100 Mbit WAN port
- Ethernet cable supplied
- ambient temperature: 0 - 45 °C
- protection degree: IP20
- mounting: can be positioned horizontally, or mounted vertically on the wall

**COMPLETE DEVICE**

**552-00001** Pieces: 1 Wireless smart hub



### Wireless motion detector, Zigbee®

The wireless motion detector can be used to control other switching contacts. For example, when motion is detected, you can control the contact of another connectable switch, dimmer or motor control.

Since the motion detector is powered by a button battery and is supplied with a self-adhesive mounting plate, it can be easily attached anywhere.

This motion detector can only be used in combination with the wireless smart hub for Niko Home Control (552-00001). This makes it possible to configure additional functionalities with the Niko Home Control programming software.

- maximum range open field (detector to smart hub): 30 m
- maximum range indoor (detector to smart hub): 10 m
- communication protocol: Zigbee® 3.0
- operating frequency: 2.4 Ghz
- input voltage: battery CR2450
- ambient temperature: 0 – +40 °C
- mounting method: surface mounting
- mounting height: 2,5 – 2,8 m
- dimensions (HxWxD): 51 x 51 x 34 mm
- weight: 69 g
- maximum radio frequency power: 7 dBm
- detector settings: Niko Home Control programming software
- protection degree: IP20



NEW

#### COMPLETE UNIT

	<b>552-80401</b>	Pieces: 1	Detector
--	------------------	-----------	----------

### Connected switching socket outlet for Niko Home Control with pin earthing and safety shutters, Zigbee®

With this connected switching socket outlet with built-in consumption measurement, you choose extra comfort, safety and energy awareness. The socket outlet can be easily installed in all new construction projects and can also easily replace an existing socket outlet in renovation projects without adapting the wiring.

You connect the socket outlet without additional cabling with a wireless switch and the wireless smart hub (552-00001) for Niko Home Control. That way you have full control over your socket outlets and can add useful new features such as an all-off or all-on function, automatic calendar functions, remote control, consumption messages and an overview of your energy consumption.

- base for flush-mounting: flush-mounting depth 32,4 mm
- connection: plug-in terminals (3 x 2 x 2.5 mm<sup>2</sup>) with unlocking system
- suitable for all standard flush-mounting boxes
- input voltage: 230 V 50 Hz (N, L)
- standby consumption: 0.5 W
- ambient temperature: 0 - 40 °C
- protection degree: IP20
- marking: CE marked
- quality mark: CEBEC
- maximum load: 16 A / 3680 W
- internal overcurrent protection: switches off at > 16 A
- internal overheating protection
- communication protocol: Zigbee® 3.0, 2.4 GHz
- button on the device to switch the phase (L) on and off locally
- LED indicator for status and error information
- measuring precision: ± 5 %

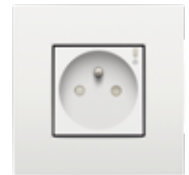

NEW

Available as from 4rd quarter 2019

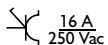

#### BASE

	<b>170-33505</b>	Pieces: 1	With plug-in terminals, for claw fixing
	<b>170-33605</b>	Pieces: 1	With plug-in terminals, for screw fixing



NEW

**Connected switching socket outlet for Niko Home Control with side earthing and safety shutters, Zigbee®**

With this connected switching socket outlet with built-in consumption measurement, you choose extra comfort, safety and energy awareness. The socket outlet can be easily installed in all new construction projects and can also easily replace an existing socket outlet in renovation projects without adapting the wiring.

You connect the socket outlet without additional cabling with a wireless switch and the wireless smart hub (552-00001) for Niko Home Control. That way you have full control over your socket outlets and you can add useful new functionalities, including:

- all-off or all-on function
  - automatic calendar functions
  - remote control
  - consumption messages
  - overview of your energy consumption.
- base for flush-mounting: flush-mounting depth 35,7 mm
  - connection: plug-in terminals (3 x 2 x 2.5 mm<sup>2</sup>) with unlocking system
  - suitable for all standard flush-mounting boxes
  - input voltage: 230 Vac ± 10 %, 50 Hz (N, L)
  - standby consumption: 0.5 W
  - ambient temperature: 0 - 40 °C
  - protection degree: IP20
  - marking: CE marked
  - quality mark: CEBEC
  - maximum load: 16 A / 3680 W
  - internal overcurrent protection: switches off at > 16 A
  - internal overheating protection
  - communication protocol: Zigbee® 3.0, 2.4 GHz
  - button on the device to switch the phase (L) on and off locally
  - LED indicator for status and error information
  - measuring precision: ± 5 %

**Available in the second quarter of 2020**

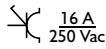

**BASE**



**170-34605** Pieces: 1

With plug-in terminals, for screw fixing

**FINISHING SET**



- 100-66930** Pieces: 1
- 104-66930** Pieces: 1
- 122-66930** Pieces: 1
- 154-66930** Pieces: 1
- 200-66930** Pieces: 1

- 101-66930** Pieces: 1
- 111-66930** Pieces: 1
- 123-66930** Pieces: 1
- 157-66930** Pieces: 1
- 220-66930** Pieces: 1

- 102-66930** Pieces: 1
- 121-66930** Pieces: 1
- 124-66930** Pieces: 1
- 161-66930** Pieces: 1
- 221-66930** Pieces: 1

## Double wireless push button

This wireless switch with two buttons can be used by a smart switch or a wireless receiver. It can be used as one dual-button control (upper=on, lower=off), or as two one-button controls (toggle on/off or pulse). The switch can also be used in the Niko Home Control installation in combination with the Niko Home Control RF interface Easywave.



- power supply: battery (supplied), type CR2430
- transmission range: ± 30 m indoors, 100 m in open spaces
- mounting: with the supplied screws or adhesive strips or (option) with a metal base on a standard flush-mounting box
- communication protocol: Easywave

### BASE



**410-00001** Pieces: 6 With plastic mounting frame and battery

### ACCESSORIES



**450-00067** Pieces: 20 Set of claws for wall-mounted printed circuit board















### BASE FOR MOUNTING ON THE FLUSH-MOUNTING BOX



**410-00022** Pieces: 6 For screw fixing (transmission range +- 25 m indoors)















### SIMPLE KEY



	<b>100-00001</b>	Pieces: 10		<b>101-00001</b>	Pieces: 10		<b>102-00001</b>	Pieces: 10
	<b>104-00001</b>	Pieces: 10		<b>121-00001</b>	Pieces: 10		<b>122-00001</b>	Pieces: 10
	<b>123-00001</b>	Pieces: 10		<b>124-00001</b>	Pieces: 10		<b>154-00001</b>	Pieces: 10
	<b>157-00001</b>	Pieces: 10		<b>161-00001</b>	Pieces: 10		<b>200-00001</b>	Pieces: 10
	<b>220-00001</b>	Pieces: 10		<b>221-00001</b>	Pieces: 10			













### SIMPLE KEY WITH 1 AND 0



	<b>100-00002</b>	Pieces: 10		<b>101-00002</b>	Pieces: 10		<b>102-00002</b>	Pieces: 10
	<b>104-00002</b>	Pieces: 10		<b>121-00002</b>	Pieces: 10		<b>122-00002</b>	Pieces: 10
	<b>123-00002</b>	Pieces: 10		<b>124-00002</b>	Pieces: 10		<b>154-00002</b>	Pieces: 10
	<b>157-00002</b>	Pieces: 10		<b>161-00002</b>	Pieces: 10		<b>200-00002</b>	Pieces: 10
	<b>220-00002</b>	Pieces: 10		<b>221-00002</b>	Pieces: 10			















### SIMPLE KEY WITH 'UP' AND 'DOWN'



	<b>100-00004</b>	Pieces: 10		<b>101-00004</b>	Pieces: 10		<b>102-00004</b>	Pieces: 10
	<b>104-00004</b>	Pieces: 10		<b>121-00004</b>	Pieces: 10		<b>122-00004</b>	Pieces: 10
	<b>123-00004</b>	Pieces: 10		<b>124-00004</b>	Pieces: 10		<b>154-00004</b>	Pieces: 10
	<b>157-00004</b>	Pieces: 10		<b>161-00004</b>	Pieces: 10		<b>200-00004</b>	Pieces: 10
	<b>220-00004</b>	Pieces: 10		<b>221-00004</b>	Pieces: 10			

### SIMPLE KEY WITH TEXT FIELD



	<b>100-00006</b>	Pieces: 10		<b>101-00006</b>	Pieces: 10		<b>102-00006</b>	Pieces: 10
	<b>104-00006</b>	Pieces: 10		<b>121-00006</b>	Pieces: 10		<b>122-00006</b>	Pieces: 10
	<b>123-00006</b>	Pieces: 10		<b>124-00006</b>	Pieces: 10		<b>154-00006</b>	Pieces: 10
	<b>157-00006</b>	Pieces: 10		<b>161-00006</b>	Pieces: 10		<b>200-00006</b>	Pieces: 10
	<b>220-00006</b>	Pieces: 10		<b>221-00006</b>	Pieces: 10			

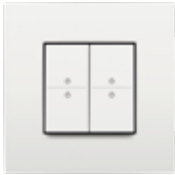

**Wireless switch with four buttons**

This wireless switch with four buttons can be used by a smart switch or a wireless receiver. It can be used as a two dual-button controls (upper: on, lower off) or as four one-button controls (toggle on/off or pulse). The switch can also be used in the Niko Home Control installation in combination with the Niko Home Control RF interface Easywave.

- power supply: battery (supplied), type CR2430
- transmission range: ± 30 m indoors, 100 m in open spaces
- mounting: with the supplied screws or adhesive strips or (option) with a metal base on a standard flush-mounting box
- communication protocol: Easywave

**BASE**



**410-00002** Pieces: 6 With plastic mounting frame and battery

**ACCESSORIES**



**450-00067** Pieces: 20 Set of claws for wall-mounted printed circuit board

**BASE FOR MOUNTING ON THE FLUSH-MOUNTING BOX**



**410-00022** Pieces: 6 For screw fixing (transmission range + - 25 m indoors)

**DOUBLE KEY**



	<b>100-00007</b>	Pieces: 10		<b>101-00007</b>	Pieces: 10		<b>102-00007</b>	Pieces: 10
	<b>104-00007</b>	Pieces: 10		<b>121-00007</b>	Pieces: 10		<b>122-00007</b>	Pieces: 10
	<b>123-00007</b>	Pieces: 10		<b>124-00007</b>	Pieces: 10		<b>154-00007</b>	Pieces: 10
	<b>157-00007</b>	Pieces: 10		<b>161-00007</b>	Pieces: 10		<b>200-00007</b>	Pieces: 10
	<b>220-00007</b>	Pieces: 10		<b>221-00007</b>	Pieces: 10			

**DOUBLE KEY WITH I AND 0**



	<b>100-00008</b>	Pieces: 10		<b>101-00008</b>	Pieces: 10		<b>102-00008</b>	Pieces: 10
	<b>104-00008</b>	Pieces: 10		<b>121-00008</b>	Pieces: 10		<b>122-00008</b>	Pieces: 10
	<b>123-00008</b>	Pieces: 10		<b>124-00008</b>	Pieces: 10		<b>154-00008</b>	Pieces: 10
	<b>157-00008</b>	Pieces: 10		<b>161-00008</b>	Pieces: 10		<b>200-00008</b>	Pieces: 10
	<b>220-00008</b>	Pieces: 10		<b>221-00008</b>	Pieces: 10			

**DOUBLE KEY WITH 'UP' AND 'DOWN'**



	<b>100-00010</b>	Pieces: 10		<b>101-00010</b>	Pieces: 10		<b>102-00010</b>	Pieces: 10
	<b>104-00010</b>	Pieces: 10		<b>121-00010</b>	Pieces: 10		<b>122-00010</b>	Pieces: 10
	<b>123-00010</b>	Pieces: 10		<b>124-00010</b>	Pieces: 10		<b>154-00010</b>	Pieces: 10
	<b>157-00010</b>	Pieces: 10		<b>161-00010</b>	Pieces: 10		<b>200-00010</b>	Pieces: 10
	<b>220-00010</b>	Pieces: 10		<b>221-00010</b>	Pieces: 10			

**DOUBLE KEY WITH LABEL**



	<b>100-00012</b>	Pieces: 10		<b>101-00012</b>	Pieces: 10		<b>102-00012</b>	Pieces: 10
	<b>104-00012</b>	Pieces: 10		<b>121-00012</b>	Pieces: 10		<b>122-00012</b>	Pieces: 10
	<b>123-00012</b>	Pieces: 10		<b>124-00012</b>	Pieces: 10		<b>154-00012</b>	Pieces: 10
	<b>157-00012</b>	Pieces: 10		<b>161-00012</b>	Pieces: 10		<b>200-00012</b>	Pieces: 10
	<b>220-00012</b>	Pieces: 10		<b>221-00012</b>	Pieces: 10			

**DOUBLE KEY WITH VENTILATOR INDICATION 0 UP TO AND INCL. 3**



	<b>100-00013</b>	Pieces: 10		<b>101-00013</b>	Pieces: 10		<b>102-00013</b>	Pieces: 10
	<b>104-00013</b>	Pieces: 10		<b>121-00013</b>	Pieces: 10		<b>122-00013</b>	Pieces: 10
	<b>123-00013</b>	Pieces: 10		<b>124-00013</b>	Pieces: 10		<b>154-00013</b>	Pieces: 10
	<b>157-00013</b>	Pieces: 10		<b>161-00013</b>	Pieces: 10		<b>200-00013</b>	Pieces: 10
	<b>220-00013</b>	Pieces: 10		<b>221-00013</b>	Pieces: 10			





### Programming software Niko Home Control II

The new software is even more user-friendly, intuitive and visually structured. The software can be downloaded free of charge from the Niko website. The software is available for Windows and Mac.

Do you want to upgrade an existing Niko Home Control I installation with this software? Please read our FAQ on [www.niko.eu](http://www.niko.eu) before upgrading.

#### NIKO HOME CONTROL II PROGRAMMING SOFTWARE

<b>550-99102</b>	Pieces: 1	Programming software for Windows
<b>550-99202</b>	Pieces: 1	Programming software for Mac



### Control app for smartphone or tablet

With this app you can use your smartphone or tablet indoors and outdoors as the central control of your Niko Home Control II installation. Install this app on an iPhone, iPad or Android smartphone or tablet. Your connected controller and mobile device must both be connected to the internet (via WiFi, 3G, 4G, GPRS) to use the app. You can control all the functionality of your Niko Home Control installation through a modern and user-friendly interface. You can use the app for switching lighting and socket outlets, dimming lighting, controlling roller shutters and sun blinds as well as for activating atmospheres and switching your heating and ventilation. The app also informs you about your home's electricity, gas and water consumption. This app also allows you to answer calls from your external video unit when you're not home. You can see the visitor, talk to them and open your door remotely if necessary. We recommend providing at least one touchscreen on top of the smartphones and/or tablets because a wired device is always more reliable than a mobile one in access control installations. You can download the app for free from the app store.

#### NIKO HOME CONTROL II CONTROL APP

<b>550-92102</b>	Pieces: 1	Niko Home Control II control app for iOS
<b>550-92202</b>	Pieces: 1	Niko Home Control II control app for Android

Blank lined writing area with horizontal ruling lines.



## Essentials

The basic installation already offers your customers more possibilities than a traditional electrical installation would. With Niko Home Control, the resident chooses simple, intuitive and always modifiable controls via push buttons with clear function symbols.

They can set preferences and add or modify moods, names and automatic time settings.

With one push of the all-off button, lighting and other systems you want shut down are all turned off. Programmed timers switch lights on and off, giving you even more control. Presence simulation and a panic button increase the feeling of safety. With their smartphone and tablet, they are always in control of their home, anywhere in the world.

Description	Ref.	Apart.	Residence	Large residence
Wireless smart hub	552-00001	1	1	1
Connected single switch	551-72101	7	8	8
Finishing set for connected single switch	xxx-32002	7	8	8
Connected double switch	551-72102	-	8	14
Finishing set for connected double switch	xxx-32004	-	8	14



## Comfortable living

Niko Home Control can not only be controlled via buttons, your smartphone or tablet, but also with a central touchscreen on the wall. With dimmers, motion detectors and mood control, your customers choose complete ease of use. For each activity, they can set the right mood which can be chosen with one push of the button. Automatically controlled lighting outside, in the toilet, storage areas and the dressing room, provides more comfort and saves energy.

Description	Ref.	Apart.	Residence	Large residence
Touchscreen	550-20102	1	1	1
Power supply for touchscreen	550-00501	1	1	2
Touchswitch	551-18000	1	2	5
Connected dimmer	551-72201	3	3	5
Finishing set for connected dimmer	xxx-32002	3	3	5
Wireless motion detector	552-80401	2	3	5
Wireless smart hub	552-00001	1	1	1
Connected single switch	551-72101	7	8	8
Finishing set for connected single switch	xxx-32002	7	8	8
Connected double switch	551-72102	-	8	14
Finishing set for connected double switch	xxx-32004	-	8	14

**Apartment** 8 light circuits + 1 circuit with switched wall sockets

**Residence:** 13 light circuits + 2 circuits with switched wall sockets

**Large residence:** 21 light circuits + 3 circuits met switched wall sockets

**Apartment:** 5 light circuits + 4 dimmable light circuits  
+ 1 circuit with switched wall sockets

**Residence:** 10 light circuits + 4 dimmable light circuits  
+ 2 circuits with switched wall sockets

**Large residence:** 18 light circuits + 6 dimmable light circuits  
+ 3 circuits with switched wall sockets





## Safe living

If Niko Home Control detects something suspicious, your customers will receive a notice on their smartphone. The roll-down shutters go up if the smoke detectors detect fire and the lighting is automatically switched on as soon as it gets dark or once motion is detected. Connection to an alarm system switches on the lighting in case of unwanted visitors. A push on the panic button switches all lights on at once. If they're not home, the presence simulation automatically controls the lighting and roll-down shutters in the morning and evening. And thanks to the video unit at the front door, they can use their touchscreen, tablet or smartphone to see who is at the door.

Description	Ref.	Apart.	Residence	Large residence
Wireless mini hand-held transmitter	05-311	1	1	1
External video unit for Niko Home Control with 1 illuminated touch button	550-22001	0	1	1
Touchscreen	550-20102	1	1	1
Power supply for touchscreen	550-00501	1	1	2
Touchswitch	551-18000	1	2	5
Power supply for touchswitch	340-00050	1	1	1
Connected dimmer	551-72201	3	3	5
Finishing set for connected dimmer	xxx-32002	3	3	5
Wireless motion detector	552-80401	2	3	5
Wireless smart hub	552-00001	1	1	1
Connected single switch	551-72101	7	8	8
Finishing set for connected single switch	xxx-32002	7	8	8
Connected double switch	551-72102	-	8	14
Finishing set for connected double switch	xxx-32004	-	8	14

**Apartment:** 8 light circuits + 1 circuit with switched socket outlets

**Residence:** 13 light circuits + 2 circuits with switched socket outlets

**Large residence:** 21 light circuits + 3 circuits met switched socket outlets



## Energy-conscious living

Thanks to zone heating, your customers heat each room at different moments and temperatures. Smart ventilation responds to presence and the lights in the room. Roll-down shutters, curtains and sun blinds are controlled automatically. With connected switchable socket outlets, your customers can easily turn connected devices on or off and measure the energy consumption of those devices. Via the touchscreen, a separate eco display, smartphone and/or tablet, they have access to their home's energy consumption at all times. Niko Home Control controls our partners' ventilation, heating and energy management systems automatically.

Description	Ref.	Apart.	Residence	Large residence
Connected motor control	551-72301	1	2	3
Finishing set for Connected motor control	xxx-32002	1	2	3
Wireless mini hand-held transmitter	05-311	1	1	1
External video unit for Niko Home Control with 1 illuminated touch button	550-22001	-	1	1
Touchscreen	550-20102	1	1	1
Power supply for touchscreen	550-00501	1	1	2
Touchswitch	551-18000	1	2	5
Power supply for touchswitch	340-00050	1	1	1
Connected dimmer	551-72211	3	3	5
Finishing set for Connected dimmer	xxx-32002	3	3	5
Wireless motion detector	552-80401	2	3	5
Wireless smart Hub	552-00001	1	1	1
Connected single switch	551-72111	7	8	8
Finishing set for Connected single switch	xxx-32002	7	8	8
Connected double switch	551-72112	-	8	14
Finishing set for Connected double switch	xxx-32004	-	8	14

**Apartment:** 8 light circuits + 1 circuit with switched socket outlets

**Residence:** 13 light circuits + 2 circuits with switched socket outlets

**Large residence:** 21 light circuits + 3 circuits met switched socket outlets



## Independent living

Easily adapt Niko Home Control to the new needs of your existing customers. Stick or screw our wireless controls precisely where your customers need them. Electrical devices that can lead to dangerous situations, such as ovens or hobs, can be turned off automatically. In emergency situations, a wireless panic button quickly warns a family member or trusted person. And when Niko Home Control does not register any movement for several hours when your customers are home, a family member will receive an alert on their smartphone. No matter what you program: your customers remain in control and can easily turn off any function.

Description	Ref.	Apart.	Residence	Large residence
Base for wireless switch	410-00001	1	1	2
Finishing set for wireless switch	xxx-00001	1	1	2
Connected motor control	551-72301	1	2	3
Finishing set for Connected motor control	xxx-32002	1	2	3
Wireless mini hand-held transmitter	05-311	1	1	1
External video unit for Niko Home Control with 1 illuminated touch button	550-22001	0	1	1
Touchscreen	550-20102	1	1	1
Power supply for touchscreen	550-00501	1	1	2
Touchswitch	551-18000	1	2	5
Power supply for touchswitch	340-00050	1	1	1
Connected dimmer	551-72201	3	3	5
Finishing set for Connected dimmer	xxx-32002	3	3	5
Wireless motion detector	552-80401	2	3	5
Wireless smart Hub	552-00001	1	1	1
Connected single switch	551-72101	7	8	8
Finishing set for Connected single switch	xxx-32002	7	8	8
Connected double switch	551-72102	-	8	14
Finishing set for Connected double switch	xxx-32004	-	8	14

**Apartment:** 8 light circuits + 1 circuit with switched socket outlets

**Residence:** 13 light circuits + 2 circuits with switched socket outlets

**Large residence:** 21 light circuits + 3 circuits met switched socket outlets



Niko designs electr(on)ic solutions to enhance buildings to better suit the needs of the people who live and work in them. By using less energy, by improving light comfort and safety and by making sure all applications work together seamlessly. Buildings with Niko are more efficient, are controllable from a distance and interact within bigger ecosystems. Niko is a Belgian family business from Sint-Niklaas with 700 employees and 10 European branches.

At Niko, there is one question that keeps us busy every day: "How can we enhance buildings to better suit your needs?"

**Niko nv**

Industriepark West 40

BE-9100 Sint-Niklaas

sales.be@niko.eu

Tel +32 3 778 90 00

Fax +32 3 777 71 20

[www.niko.eu](http://www.niko.eu)

**niko**  
*Illuminating ideas.*